

KAYO MOTO

KT250

Maintenance Manual



WWW.KAYOMOTO.COM

This service manual is edited by KAYO

No part of this publication may be reproduced without authorization.

ZHEJIANG KAYO MOTOR CO., LTD reserves the right to make changes at any time without notice and without incurring any obligation.

The vehicle pictured in this owner's manual may not match your actual vehicle.

PREFACE

Congratulations on your purchase of the KT250 Dirt Bike, and we believe that this choice won't let you down.

This manual will give you an understanding of the better use of our product. It has specialized the maintenance and adjustment procedures, disassembly and assembly points, inspection and repair points, troubleshooting methods and maintenance technical data, in addition, there is a detailed graphic information to guide the operation.

Please read this manual carefully and carry out maintenance according to the standard operation techniques, which can effectively prolong the service life of each component, improve the engine performance and the reliability of the vehicle.

For the sake of technical development, KAYO will reserve the right of modifying motorcycle structure, equipment, and spare parts without notice. Due to that different markets have different law's requirement, we've adjusted model accordingly, the model image in this manual maybe not match your actual vehicle. In addition, if there is any question concerning this manual, please visit our website www.kayomoto.com and consult our customer service.

The contents of this manual are subject to change without prior notice due to vehicle improvement. The actual state of the motorcycle shall prevail during maintenance.

ZHEJIANG KAYO MOTOR CO., LTD.
ENGINEERING OFFICE
MARCH. 2021

CONTENT

MEANINGS OF REPRESENTATION	9
SYMBOLS USED.....	9
DEGREES OF RISK AND SYMBOLS	9
ADVICE.....	10
APPEARANCE	11
KT250 COMPONENTS AND POSITIONS.....	11
VIN CODE, CHASSIS NUMBER AND ENGINE NUMBER.....	13
VIN CODE.....	13
CHASSIS NUMBER.....	13
ENGINE NUMBER.....	13
PARAMETER.....	14
DIMENSION AND QUALITY PARAMETER.....	14
CONTROLS.....	16
CLUTCH LEVER.....	16
FRONT DISC BRAKE.....	16
THROTTLE LEVER.....	17
STARTING.....	17
STOPPING.....	17
FUEL TANK SWITCH.....	18
SHIFTING.....	18
REAR DISC BRAKE.....	19
PARKING SUPPORT.....	19
HOUR COUNTER.....	20
PREPAREING FOR USE	21
ADVICE ON FIRST USE.....	21
RUNNING-IN PROCESS.....	21
RIDING INSTRUCTIONS.....	22
PREPARATION BEFORE RIDING.....	22
PRECAUTIONS FOR STARTING.....	22
PREACUSTIONS STOPPING.....	22
PREACUTIONS FOR TURNING.....	23
PRECAUTIONS FOR ACCELERATION.....	23
PRECAUTIONS FOR SHIFTING.....	23
PRECAUTIONS FOR BRAKING.....	23
PRECAUTIONS FOR STOPPING & PARKING.....	23
SUGGESTED INSPECTION TIME FOR ALL PARTS OF THE VEHICLE.....	24
SUSPENSION SYSTEM.....	25
CHECK THE COMPRESSION AND REBOUND OF THE VEHICLE INCLUDING THE DRIVER.....	25
ADJUSTING THE LOW-SPEED COMPRESSION DAMPING OF THE REAR SHOCK ABSORBER.....	25
ADJUSTING THE HIGH-SPEED COMPRESSION DAMPING OF THE REAR SHOCK	

ZHEJIANG KAYO MOTOR CO., LTD.

ABSORBER.....	25
ADJUSTING THE REBOUND DAMPING OF THE REAR SHOCK ABSORBER.....	26
MEASURE THE DISTANCE BETWEEN THE CENTER OF THE REAR WHEEL AND THE REAR FENDER IN SUSPENSION.....	26
MEASURE DISTANCE BETWEEN CENTER OF REAR WHEEL AND REAR FENDER UNDER NO LOAD.....	26
MEASURE DISTANCE BETWEEN REAR WHEEL CENTER AND REAR FENDER IN DRIVING CONDITION.....	27
ADJUSTING THE SPRING PRELOAD OF REAR SHOCK ABSORBER.....	27
CHECK FOR THE SETTING OF FRONT SHOCK ABSORBER.....	27
ADJUSTING THE COMPRESSION DAMPING OF FRONT SHOCK ABSORBER.....	28
ADJUSTING THE REBOUND DAMPING OF FRONT SHOCK ABSORBER.....	28
ADJUSTING THE HANDLEBAR.....	28
VEHICLE MAINTENANCE.....	29
PLACEMENT.....	29
REMOVING OR INSTALLING THE DISC BRAKE COVER.....	29
REMOVING OR INSTALLING THE FRONT SHOCK ABSORBER GUARD PLATE.....	29
REMOVING OR INSTALLING THE FRONT DISC BRAKE.....	30
REMOVING OR INSTALLING THE FRONT SHOCK ABSORBER.....	30
REMOVING OR INSTALLING THE LINKAGE.....	30
CHECK THE FRONT STEERING.....	31
LUBRICATION AND INSTALLATION OF STEERING HEAD BEARING.....	31
REMOVING OR INSTALLING FRONT HEADLIGHT.....	32
REMOVING OR INSTALLING THE FRONT FENDER.....	32
REMOVING OR INSTALLING THE REAR SHOCK ABSORBER.....	33
REMOVING OR INSTALLING THE SEAT CUSHION.....	33
REMOVING OR INSTALLING THE AIR FILTER HOUSING.....	34
REMOVING OR INSTALLING THE AIR FILTER.....	34
CLEANING AND MAINTENANCE OF AIR FILTER.....	35
REMOVING OR INSTALLING THE EXHAUST PIPE.....	35
REMOVING OR INSTALLING THE MUFFLER TUBE.....	36
REMOVING OR INSTALLING THE FUEL TANK.....	36
CHECK AND CLEAN THE CHAIN.....	36
REMOVING OR INSTALLING THE CHAIN.....	36
CHECK AND ADJUST THE CHAIN TENSION.....	38
CHECK THE STRUCTURE OF THE REAR SPROCKET, ENGINE SPROCKET AND GUIDE CHAIN.....	39
CHECK THE FRAME.....	39
CHECK THE FORK.....	39
CHECK THE THROTTLE CABLE.....	39
CHECK THE STEERING HANDLE.....	40
ADJUST THE POSITION OF THE CLUTCH HANDLE.....	40
CHECK THE FLUID LEVEL OF THE HYDRAULIC CLUTCH / REPLENISH THE TRANSMISSION FLUID.....	40

ZHEJIANG KAYO MOTOR CO., LTD.

CHECK AND MAINTENANCE THE BRAKE SYSTEM.....	41
CHECK THE FREE-PLAY OF FRONT BRAKE LEVER.....	41
CHECK THE CABLE OF FRONT BRAKE LEVER.....	41
CHECK THE DISC BRAKE.....	42
CHECK THE FRONT BRAKE LIQUID LEVEL.....	42
REFUEL THE FRONT BRAKE LIQUID LEVEL.....	43
CHECK THE FRONT BRAKE PADS.....	43
CHECK THE FREE-PLAY OF FOOT BRAKE.....	43
CHECK THE REAR BRAKE DISK LIQUID LEVEL.....	44
REFUEL THE REAR BRAKE DISK LIQUID LEVEL.....	44
CHECK THE REAR BRAKE PADS.....	45
TIRE INSPECTION AND MAINTENANCE.....	46
REMOVING OR INSTALLING THE FRONT WHEEL.....	46
REMOVING OR INSTALLING THE REAR WHEEL.....	46
TIRE INSPECTION.....	46
CHECK TIRE PRESSURE.....	47
CHECK SPOKE.....	47
ELECTRICAL SYSTEM.....	48
REMOVING OR INSTALLING THE BATTERY.....	48
CHANGING THE BATTERY.....	48
MAIN CABLE	
KT250 VEHICLE WIRING DIAGRAM.....	49
COOLING SYSTEM.....	50
COOLING SYSTEM PROFILE.....	50
REMOVING OR INSTALLING THE COWLING AND HOSE.....	50
CHECK ANTIFREEZE LEVEL.....	51
DRAIN OUT THE COOLANT.....	51
FILLING THE COOLING SYSTEM.....	52
INTRODUCING ABOUT THE ENGINE STRUCTURE	53
INSTALLING THE ENGINE.....	53
ENGINE MAINTENANCE AND ADJUSTMENT.....	53
CHECK THE VALVE CLEARANCE.....	53
COMPRESSION PRESSURE CHECK.....	54
ADJUSTMENT OF CLUTCH CONTROL SYSTEM.....	54
THE ENGINE ADJUSTMENT.....	55
IDLE SPEED ADJUSTMENT OF CARBURETOR.....	55
CLEAN THE CARBURETOR.....	55
CHECK THE SHIFT LEVER POSITION.....	56
ADJUST THE SHIFT LEVER POSITION.....	56
INSPECTION OR REPLACEMENT OF SPARK PLUGS.....	56
LUBRICANT SELECTION.....	57
LUBRICANT INSPECTION.....	57
LUBRICANT REPLACEMENT.....	58
REMOVAL OR INSTALLING THE OIL PUMP.....	58

ZHEJIANG KAYO MOTOR CO., LTD.

OIL PUMP INSPECTION.....	59
COMMON PROBLEMS AND CAUSES OF LUBRICATION SYSTEM	60
REMOVAL OF THE COOLING PUMP.....	60
INSTALLATION OF COOLING PUMP.....	60
ENGINE CYLINDER BLOCK AND PISTON.....	61
CYLINDER BLOCK AND PISTON PARTS SPECIFICATIONS.....	61
REMOVAL OF CYLINDER BLOCK.....	62
CYLINDER BLOCK INSPECTION.....	62
REMOVAL OF PISTON.....	62
PISTON AND PISTON RING INSPECTION.....	63
CLEANING AND INSPECTION OF CYLINDER HEAD.....	63
CHECK THE CLEARANCE BETWEEN CYLINDER AND PISTON.....	64
MEASURE THE DIAMETER OF PISTON PIN AND PIN HOLE.....	64
INSTALLATION OF PISTON RING.....	64
INSTALLATION OF PISTON.....	65
INSTALLATION OF CYLINDER BLOCK.....	66
REMOVAL OR INSPECTION OF CLUTCH.....	66
CLUTCH PARTS SPECIFICATIONS.....	66
REMOVAL OF THE RIGHT CRANKCASE COVER.....	66
REMOVAL THE CLUTCH.....	67
CLUTCH INSPECTION.....	67
INSTALLATION OF CLUTCH.....	68
INSTALLATION OF THE RIGHT CRANKCASE COVER.....	69
REMOVAL OR INSTALLATION OF THE SHIFT MECHANISM IN THE ENGINE.....	70
MAGNETO AND ELECTRIC STARTING PARTS OF ENGINE.....	71
REMOVAL OR INSTALLATION OF STARTER MOTOR.....	71
REMOVAL OR INSTALLATION OF LEFT CRANKCASE COVER.....	71
REMOVAL OR INSTALLATION OF MAGNETO STATOR.....	72
REMOVAL OR INSTALLATION OF THE MAGNETO ROTOR.....	72
REMOVAL OR INSTALLATION OF ELECTRIC START GEAR.....	72
ENGINE CRANKSHAFT AND TRANSMISSION MECHANISM.....	73
PREPARATIONS BEFORE REMOVING THE CRANKCASE.....	73
SPECIFICATIONS OF CRANKSHAFT AND TRANSMISSION MECHANISM.....	73
REMOVAL OF CRANKCASE.....	74
REMOVAL OF THE TRANSMISSION MECHANISM.....	74
CRANKSHAFT INSPECTION.....	74
TRANSMISSION MECHANISM INSPECTION.....	75
INSTALLATION OF TRANSMISSION MECHANISM.....	76
INSTALLATION OF REMAINING PARTS.....	77
ENGINE TIGHTENING TORQUE TABLE.....	78
TROUBLESHOOTING.....	78
SELECTION AND RATIO OF ENGINE OIL.....	81
MOTORCYCLE CLEANING.....	83
STORAGE.....	83

ZHEJIANG KAYO MOTOR CO., LTD.

PREPARING FOR LONG STORAGE.....	83
PREPARING FOR USE AFTER LONG STORAGE.....	84
MAINTENANCE POINTS.....	84
TIGHTENING TORQUE TABLE FOR THE WHOLE VEHICLE.....	89

MEANINGS OF REPRESENTATION

SYMBOLS USED

The meaning of specific symbols is described below

* All work marked with this symbol requires specialist knowledge and technical understanding. If you do not have the confidence to perform that, you can go to an authorized KAYO workshop or KAYO after-sale service point. There, your motorcycle will be optimally cared for by specially trained experts using the specialist tools required.

→ Indicates a page reference (more information is provided on the specified page).

DEGREES OF RISK AND SYMBOLS

Your safety, and the safety of others, is very important. Operating this motorcycle safely is an important responsibility. Please read this manual carefully.

Safety Messages preceded by a safety alert symbol and one of three signal words:

DANGER: Indicates a danger that will immediately and invariably lead to fatal or permanent injury if the appropriate measures are not taken.

WARNING: Indicates a danger that is likely to lead to fatal or serious injury if the appropriate measures are not taken.

CAUTION: Indicates a danger that may lead to minor injuries if the appropriate measures are not taken.

Other important information:

Please note that it is not practical or possible to warn you about all hazards associated with operating or maintaining a motorcycle.

Therefore, you must have basic mechanical safety knowledge and use your own good judgement. If you cannot complete the process of operating or maintaining, please consult a more experienced senior technician before operation.

ADVICE

Most of off-road motorcycle fatalities are caused by head injuries. Without helmets, the chances of serious injury or death caused by head injuries are much higher. So always wear an approved motorcycle helmet and protective apparel such as goggles, gloves and boots while riding, which will save your life at the critical moment.

Initially, this series of vehicles were designed for off-road racing, without considering the problem of carrying passengers, and what's more, there is no backseat, handlebar and pedal for carrying people. So please be sure not to use this motorcycle to carry any other people except the driver, which may easily lead to a safety accident.

Do not use non-original parts to modify the car, and do not arbitrarily remove the original components from the vehicle. If you need to replace any parts, please use spare parts and accessory products that are approved and/or recommended by KAYO and have them installed by an authorized KAYO workshop. KAYO accepts no liability for any personal modification, other products and any resulting damage or loss.

Our KT series products are specially designed for off-road and woodland crossing, so they are not suitable for highway or long-distance riding.

If you insist on using them in that way, the tires may be overused due to high speed rotation and shorten its service life.

It is also not suitable for urban use, as long waiting time at traffic lights may cause the engine to overheat and shorten its service life.

Please take care of your vehicle and avoid any problem caused by improper use.

Please check your motorcycle carefully before riding and do the maintenance accordingly after use. When the motorcycle fell, check the main parts first. It would lead to an accident easily and endanger your own safety when riding a faulty vehicle.

When using this motorcycle, the temperature of the engine and exhaust pipe is very high, so it needs a period to cool down after parking. During this period, do not touch or move the engine or exhaust pipe to avoid scald.

Do not wear shorts while riding, otherwise leg injuries may happen.

ZHEJIANG KAYO MOTOR CO., LTD.

APPEARANCE

KT250 COMPONENTS AND POSITIONS



No.	Name	No.	Name
1	Front fender	10	Front brake caliper
2	Headlight	11	Front shock
3	Handlebar	12	Fuel tank
4	Vent pipe	13	Carburetor
5	Fuel tank cap	14	Gear shift lever
6	Fuel tank petcock	15	Pedal
7	Air filter cover	16	Chain
8	Chain guide cover	17	Chain guide
9	Front disc brake cover	18	Rear sprocket

ZHEJIANG KAYO MOTOR CO., LTD.



27 28 29 30 31 32 33 34 35

No.	Name	No.	Name
19	Taillight	28	Rear brake caliper
20	Rear fender	29	Aluminum swingarm
21	Exhaust pipe muffler	30	Triangle rocker arm
22	Seat	31	U-shape rocker arm
23	Rear shock	32	Rear brake oil cup
24	Upper clamp	33	Brake pedal
25	Cooling water tank	34	Exhaust pipe
26	Lower clamp	35	Front disc brake
27	Rear disc brake		

VIN CODE

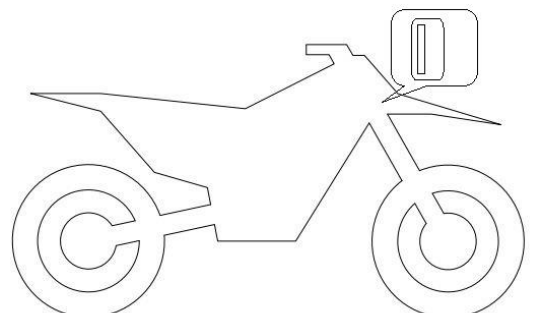

Vin code of KT50, KT85,KT250 are located on the head pipe.

CHASSIS NUMBER



Chassis Number of KT50、KT85、KT250 are located on the nameplate.

ENGINE NUMBER

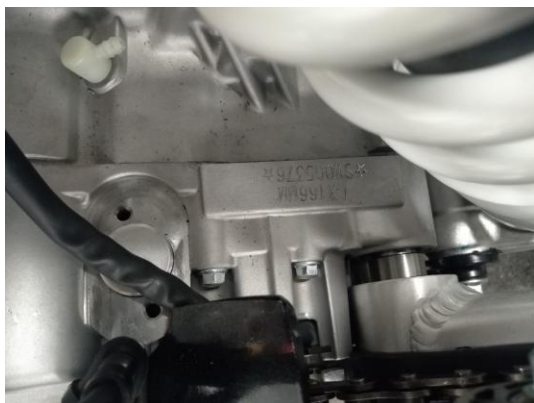

The engine number of KT250 is located on the engine box behind the cylinder block.

ZHEJIANG KAYO MOTOR CO., LTD.

PARAMETER

DIMENSIONS AND QUALITY PARAMETER - KT250	
L*W*H (mm)	2180×820×1254
Wheelbase (mm)	1488
Net weight (kg)	110
Tire size	F: 80/100-21; R: 110/100-18
Seat height (mm)	955
Min ground clearance (mm)	344
Tank volume (L)	7.5
Engine Parameters	
Engine type	Single cylinder, two stroke, water cooling, vertical
Clutch type	Wet type, Multiple disk
Cylinder diameter×stroke	66.8×64mm
Oil	TORCO GP-7 total synthesis
Displacement	224cc
Max. Power (kw/r/min)	29/8500
Max. Torque(NM/r/min)	36/7500
Compression Ratio	6.5:1
Shift type	Usually engaged two - stage transmission six - speed transmission, International profile 1-N-2-3-4-5-6
Starting	Electric
Fuel control system	PWK competitive carburetor
Battery	Lithium battery for high performance electric starting, very light in weight
Chain	#520, 12T/51T
Frame/Shock/Brake/Wheel system Parameters	
Frame type	Central double cradle type high-strength steel tube frame, KAYO International patent design
Front shock	Inverted dual adjustable front shock, L=950mm, 300mm stroke
Rear shock	Compression recovery dual adjustable nitrogen airbag rear shock, L=480mm, 110mm stroke, CRF general configuration
Swingarm	High strength aluminum alloy internal high-pressure forming structure, improved progressive rate of forged aluminum connecting rod system

ZHEJIANG KAYO MOTOR CO., LTD.

Handlebar	Competitive high-strength aluminum alloy fat bar (imported),, material 7075 Φ 28.6mm, with Kayo special ultra-soft off-road grip
F/R rims	F 1.60×21, R 2.15×18, 7050 high strength aluminum rim , forged CNC wheel hub
F brake system	NISSIN double piston pump hydraulic brake system, Φ 240mm, CNC ergonomic small handle bar
R brake system	NISSIN single piston pump hydraulic brake system, Φ 240mm, forged internal brake pedal
Others	
Air filter type	Sponge filter core filter type
Fuel type	92# and above grade gasoline
Motorcyclists	1 person (rider)
Maximum load mass	120kg

CONTROL

CLUTCH



clutch lever

The clutch is controlled by the clutch lever, which is fitted on the left side of the handlebar and functioned by pinching the lever with your left hand.

By adjusting the screw, you can change the distance between the clutch lever and handlebar as you wish. This adjustment will not either change the structure or affect the normal use.

FRONT DISC BRAKE



hand brake lever

The front disc brake is controlled by the hand brake lever, which is fitted on the right side of the handlebar and functioned by the pinching the lever with your right hand.

By adjusting the screw, you can change the distance of the brake lever and handlebar as you wish. This adjustment will not either change the structure or affect the normal use.



front brake calipers

The front wheel adopts the floating-caliper disc brake, which is installed under the left front shock and fixed by two bolts.

THROTTLE LEVER



throttle lever

The throttle lever is located on the right side of the handlebar and is controlled by turning with the right hand.

Turn the handle counterclockwise to increasing the engine. It will back to normal smoothly once you lease the handle.

STARTING



start button

The start button is a square gray one and fitted on the right side of the handlebars, near the throttle grip. It needs long press on the button when starting.

Attention: When starting, you should pinch the brake with your left hand to prevent sudden starting when the transmission is I gear.

Attention: There should have fuel in the fuel tank before starting the engine, and the fuel tank switch should be in the open position.

The KT250 engine has no kick start model and is only electric start through the start button.

STOPPING



stopping button

The stopping button is square red one and fitted on the left side of the handlebar near the grip.

It needs long press on the button when stopping.

FUEL TANK SWITCH

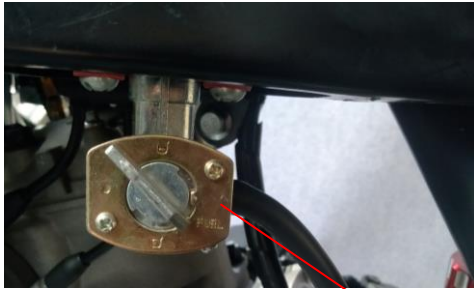

fuel tank switch

The fuel tank switch is located on the bottom left side of the fuel tank. By turning the switch, you can control the entrance of the fuel into the carburetor, so as to achieve the control purpose.

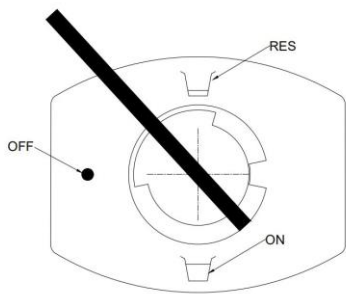

The meaning of symbols on the oil tank switch is shown as the left picture.

“ON”: indicates that the switch is opened for oil discharge.

“OFF”: indicates that the switch is closed, and the oil discharge is stopped.

“RES”: indicates that the reserve oil is activated.

SHIFTING

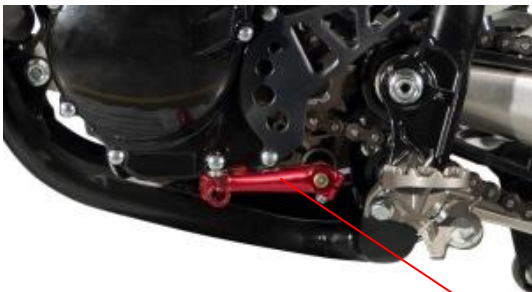

gearshift

The gearshift is located on the left side of the engine, which is functioned by stepping on and hooking on the shift lever.

The KT50 engine has no gear, so there is no shift lever.

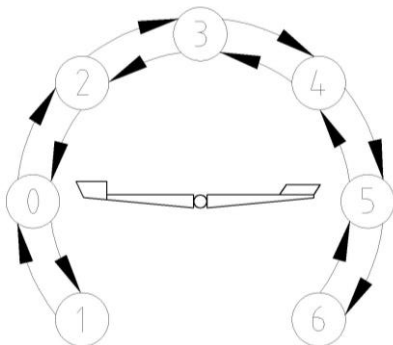

The KT250 engine has six gear as International Standard, and you can find the illustration on the left.

REAR DISC BRAKE



foot brake pedal

The foot brake pedal is located on the right side of the engine and is functioned by stepping.

Note: In actual use, the brake operation should be mainly through foot brake, use hand brake as a supplement.



rear brake caliper

The rear brake adopts a floating clamp disc brake, which one is located on the right side of the rear wheel and fixed by a disc brake bracket.

PARKING SUPPORT

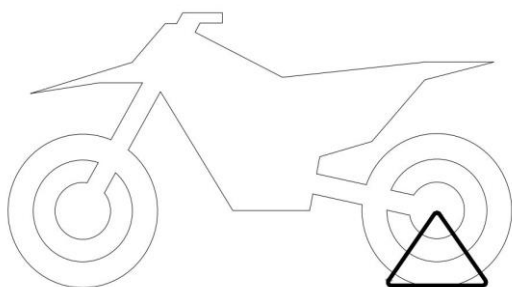

The KT250 uses a triangle side stand for parking. When parking, make the top side insert into the axle hole of the rear wheel, and slowly lean the motorcycle to the left until its weight rests on the side stand.

HOUR COUNTER



The KT250 hour meter is located on the main beam tube at the front end of the fuel tank of the frame.

PREPARING FOR USE

ADVICE ON FIRST USE

1. Before your first trip, read the entire operating instructions carefully, especially the section of “Controls” and “Riding Instructions”.
2. When driving, please carry out a standardized run-in first.
3. If any parts problems are found during using, you can repair that according to this manual or contact KAYO Dealers for professional aid.
4. After each use, clean the vehicle with running water.
5. Do not drive in inclement weather (e.g. rainstorm, blizzard, etc.) unless necessary.
6. KAYO is not responsible for any vehicle problems caused by malicious acts.

RUN-IN PROCESS

Motorcycle engines have a lot of relative moving parts, such as pistons, piston rings, cylinder blocks, meshing transmission gears, etc. Therefore, in the initial stage of use, the engine must be standardized. The running-in can make the moving parts adapt to each other, correct the working gap, and form a good smooth friction surface that can withstand larger loads. Only after standard running-in can the engine have excellent performance and reliability.

The recommended running-in steps are as follows:

1. 0-2.5h stage: Using under the throttle level of 50% ~ 75%, the speed should be changed frequently to avoid the motorcycle working at the same condition for a long time,
Let the engine rest and cool down for 5 ~ 10 minutes after each 1-hour work.
Do not accelerate suddenly to protect your throttle.
2. 2.5-4h stage: Using under the throttle level of 50% ~ 75% throttle and work for a long time at the same condition.
In actual working, the throttle can be up to full level, but not more than 5 ~ 10 seconds;
3. 4-5h stage: Using under the throttle level of 75% ~ 100%
4. More than 5h: increase the speed to 60 ~ 80km/h, until the engine performance can be fully played.

DANGER: When riding a motorcycle, please do not speed up regardless of the consequences, this behavior is easy to cause engine damage and causing safety accidents therewith.
So, please ride the vehicle properly.

RIDING INSTRUCTIONS

PREPARATION BEFORE RIDING

1. Check fuel level in fuel tank and replenish if necessary.
2. Check fluid level in hand brake fluid reservoir and replenish if necessary.
3. Check fluid level in foot brake fluid reservoir and replenish if necessary.
4. Check brake pad wear condition at the hand brake clamp system.
5. Check brake pad wear condition at the foot brake clamp system.
6. Check braking system operate condition.
7. Check antifreeze level.
8. Check the chain.
9. Inspect rear sprocket, engine sprocket and chain guide structure.
10. Check the chain adjuster.
11. Check the outer surface of the tire.
12. Check tire pressure.
13. Check battery level.
14. Check the thickness of the front disc brake.
15. Check the thickness of the rear disc brake.
16. Check the torque of each fastener.
17. Check the engine gear.
18. Check cover parts.
19. Check the fuel tank switch.
20. Check protective apparels are all-ready worn.

PRECAUTIONS FOR STARTING

The steps of electric ignition are as follows:

1. Turn the oil tank switch to the "ON" position;
2. Open the electric lock;
3. Pinch the clutch lever with the left hand;
4. Pinch the brake lever with the right hand;
5. Long Push the ignition switch with the fingers of right hand;
6. Release the ignition switch after the engine works properly.

That's all for starting.

PRECAUTIONS FOR STOPPING

1. Check the condition of the vehicle and the rider's Equipment before starting off.
2. Speed up slowly when just starting off.
3. Start in gear "1" for ensure safety.

ZHEJIANG KAYO MOTOR CO., LTD.

PRECAUTIONS FOR TURNING

1. Take care to slow down in advance when turning
2. Lower your center of gravity to reduce the risk of side rolling when turning
3. Do not shift gears when turning

PRECAUTIONS FOR ACCELERATION

1. Do not accelerate in the corner
2. Remember to shift gears after acceleration

PRECAUTIONS FOR SHIFTING

1. Pinch the clutch lever before shifting gears
2. Do not rev the engine when shifting gears
3. Do not shift gears in the corner

PRECAUTIONS FOR BRAKING

1. Use foot brake as your first brake operation, if necessary, use hand brake as a supplement.
2. Check fluid level in the brake fluid reservoir frequently
3. Replenish the brake fluid reservoir if necessary according to the procedure in the manual

PRECAUTIONS FOR STOPPING & PARKING

1. Slow down gradually to 0 and then stop, do not make an emergency brake
2. Slowly lean the motorcycle to the left until its weight rests on the side stand.
3. Shift the gear to “N” before stopping.

ZHEJIANG KAYO MOTOR CO., LTD.

SUGGESTED INSPECTION TIME FOR ALL PARTS OF THE VEHICLE

	every 10 hours/after every race 1 hour after each ride	every 20 hours	every 30 hours
Check and charge the battery	●	●	●
Check the front disc brake plate→p.49	●	●	●
Check the rear disc brake plate→p.51	●	●	●
Check the front and rear disc brake discs→p.48	●	●	●
Inspect brake tubing for damage or leakage	●	●	●
Check the rear disc brake fluid level→p.50	●	●	●
Check the free-play of the brake pedal→p.50	●	●	●
Check the frame and swingarm	●	●	●
Check the swingarm bearing for loose		●	
Check the top of the shock absorber	●	●	●
Check the shock absorber connecting	●	●	●
Check tire surface condition→p.52	○	●	●
Check tire pressure→p.53	○	●	●
Check hub bearings for loose	●	●	●
Check the wheel hub	●	●	●
Check for rim edge pulsation	○	●	●
Check the spoke tension→p.53	○	●	●
Check chain, rear sprocket, engine sprocket, guide sleeve and chain	●	●	●
Check chain tension→p.45	○	●	●
Lubricate all moving parts (chain, handlebars, etc.) and check for smooth	●	●	●
Check the front disc brake fluid level→p.49	●	●	●
Check the free play of brake handlebar→p.48	●	●	●
Check whether the steering head bearing for loose	○	●	●
Check valve clearance	○		●
Check clutch		●	
Replace the cap seal and shaft seal ring of the pump			●
Change the gear oil	○	●	●
Inspect all hoses (e.g. fuel, cooling, exhaust, drainage, etc.) and casing for	○	●	●
Check antifreeze fluid and level→p.59	○	●	●
Check the cable for damage and sharp bend	●	●	●
Check that the throttle cable is intact, free of sharp bends, and set correctly	○	●	●
Clean air filter and air filter tank	●	●	●
Check whether screws and nuts are tightened	○	●	●
Replace the fuel filter	○	●	●
Check carburetor idle	○	●	●
Check front and rear light fixtures			
Final inspection: check whether the vehicle is running safely and conduct a test	○	●	●

○ One-off interval

● Periodic interval

ATTENTION: This table is for reference only. Please adjust the maintenance cycle of the motorcycle according to the specific model and use situation.

WARNING: For the inspection, adjustment and replacement of the engine, please consult Kayo Service Center to avoid damage.

SUSPENSION SYSTEM

CHECK THE COMPRESSION AND REBOUND OF THE VEHICLE INCLUDING THE DRIVER

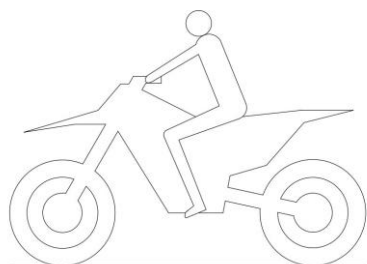
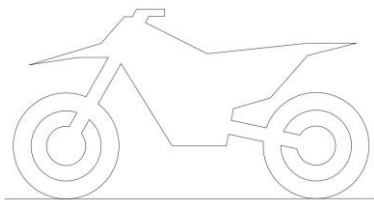

To ensure the best driving characteristics of the vehicle and avoid damage to swingarm, shock absorbers, linkage and frame, the basic setting of the suspension components must match the driver's weight.

The total standard rider mass of the KT250 off-road motorcycle is shown in the table below.

KT250	75~85KGS
-------	----------

If the rider's weight is above or below the standard range, the basic setting must be adjusted accordingly. A small weight difference can be compensated by adjusting the rear shock absorber spring preload, but if the weight difference is large, the spring must be replaced.

ADJUSTING THE LOW-SPEED COMPRESSION DAMPING OF THE REAR SHOCK ABSORBER



adjusting screws

You can adjust the low-speed compression damping by adjusting the screws with a screwdriver.

Turn counterclockwise to decrease damping(soft), or turn clockwise to increase damping(hard).

ADJUSTING THE HIGH-SPEED COMPRESSION DAMPING OF THE REAR SHOCK ABSORBER



adjusting nut

You can adjust the high-speed compression damping by adjusting the nuts with a wrench or T-shaped tool.

Turn counterclockwise to decrease damping(soft) or turn clockwise to increase damping(hard).

ADJUSTING THE REBOUND DAMPING OF THE REAR SHOCK ABSORBER

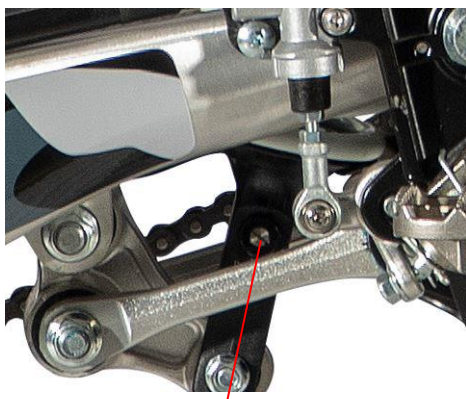

adjusting screws

You can adjust the rebound damping by adjusting the screws with a screwdriver.

Turn counterclockwise to decrease damping(soft), or turn clockwise to increase damping(hard)

MEASURE THE DISTANCE BETWEEN THE CENTER OF THE REAR WHEEL AND THE REAR FENDER IN SUSPENSION

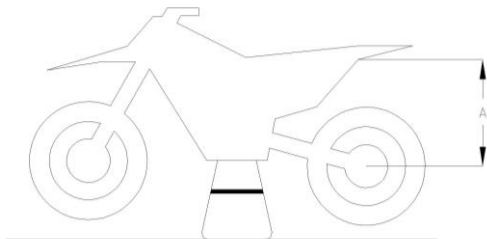

The measurement procedure is as below:

1. Place your motorcycle on its center stand stably.
2. Select a fixed point on the side of the rear fender and mark it as "point 1".
3. Measure the distance from "Point 1" to the center of the rear axle and record it as "A1".
4. Remove the motorcycle from the rack

MEASURE DISTANCE BETWEEN CENTER OF REAR WHEEL AND REAR FENDER UNDER NO LOAD

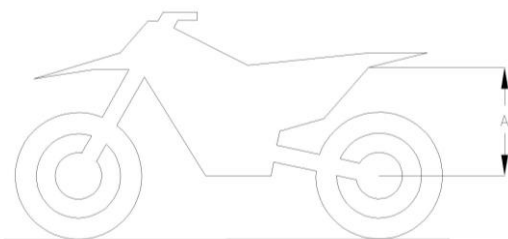

The measurement procedure is as follows:

1. The motorcycle is up right so that the center surface of the tire is perpendicular to the ground
2. Measure the distance from the center of the rear wheel axle of the motorcycle to "point 1" and record it as "A2".
3. Use a single stand to support the vehicle
4. Calculate the difference between "A1" and "A2" and denote it as "D1".

The value of "D1" when KT250 motorcycle leaves factory is shown below

	D1
KT250	10~34mm

ZHEJIANG KAYO MOTOR CO., LTD.

MEASURE DISTANCE BETWEEN REAR WHEEL CENTER AND REAR FENDER IN DRIVING CONDITION

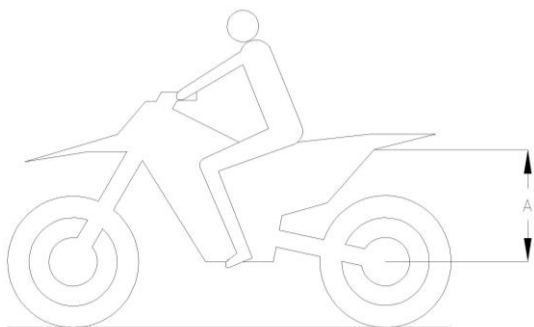

The measurement procedure is as follows:

1. The driver rides the motorcycle (the engine does not start)
2. Up right the motorcycle so that the center surface of the tire is perpendicular to the ground
3. Measure the distance from the center of the rear wheel axle of the motorcycle to "point 1" and record it as "A3".
4. The driver uses a single stand to support the vehicle and leave the seat

Calculate the difference between "A1" and "A2" and denote it as "D2".

The factory default value of "D2":

	D2
KT250	50~100mm

If "D2" measured by the customer is lower than the factory value, you should decrease the spring preload appropriately; Conversely, increase the spring preload.

If "D2" is far less than the factory value, replace the spring with a softer one; Conversely, replace the spring preload with a harder one.

ADJUSTING THE SPRING PRELOAD OF REAR SHOCK ABSORBER

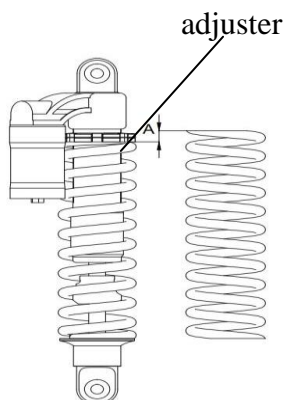

You can adjust the spring preload by adjuster.

Turn clockwise to increase spring preload,

Turn counterclockwise to decrease spring preload.

CHECK FOR THE SETTING OF FRONT SHOCK ABSORBER

The inspection procedure is as follows:

1. Place the whole motorcycle on the ground
2. Up right the vehicle
3. Hold the handlebars with both hands and press down on the front shock absorber
4. Observe the effect of pressure and rebound of front shock absorber

If it is difficult to press the front shock absorber, decrease the compression damping appropriately.

ZHEJIANG KAYO MOTOR CO., LTD.

If it is difficult to rebound the front shock absorber, decrease the rebound damping appropriately. When the ambient temperature is high, the front shock absorber should also be properly deflated.

ADJUSTING THE COMPRESSION DAMPING OF FRONT SHOCK ABSORBER



Adjusting Steps as follows:

1. Check the front shock absorber, to determine whether there is a need to adjust the damping
2. Remove the handlebars
3. Adjust the damping by rotating, using a screwdriver.

Turn clockwise to increase compression damping,
Turn counterclockwise to decrease compression damping.

ADJUSTING THE REBOUND DAMPING OF FRONT SHOCK ABSORBER



damping adjusting screw

Adjusting Steps as follows:

1. Check the front shock absorber, to determine whether there is a need to adjust the damping
2. Adjust the damping by rotating, using a screwdriver.

Turn clockwise to increase rebound damping,
Turn counterclockwise to decrease rebound damping.

ADJUSTING THE HANDLEBAR



The handlebars of the vehicle can be adjusted according to the customer's driving habits. The specific steps are as follows:

1. Remove the sheath and sheath on the handlebar.
2. Unscrew the pressure block bolt so that the handlebar can be turned.
3. Sit on the whole vehicle and hold the handlebar to the position where both hands are placed naturally.
4. Screw back the pressure block bolt.
5. Observe the position of the handlebar, if not satisfied, repeat the above process.

VEHICLE MAINTENANCE PLACEMENT

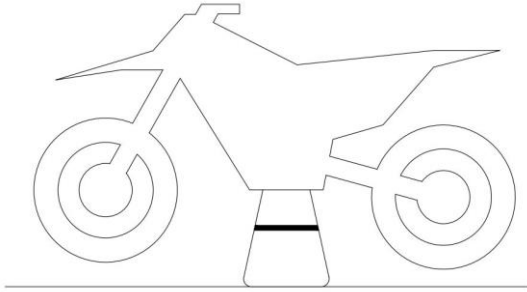

Raise your motorcycle on its center stand always when carrying out the related maintenance.
It is helpful to remove or install various parts.

REMOVING OR INSTALLING THE DISC BRAKE COVER



Removing steps are as follows:

1. Turn the front head to the vertical position.
2. Use a 5mm hexagon wrench to remove the mounting screws.

Installing steps:

The installment should be carried out in the reverse order of removal.

REMOVING OR INSTALLING THE FRONT SHOCK ABSORBER GUARD PLATE



Removing Steps are as follows:

1. Remove the mounting screw from the front shock absorber protection plate.
1. Remove the oil pipe clip.
2. Remove the guard plate.

Installing steps:

The installment should be carried out in the reverse order of removal.

NOTE: when removing the front shock absorber guard plate of KT250, the front wheel should be removed first, otherwise the screws on the inside near the tire cannot be removed.

REMOVING OR INSTALLING THE FRONT DISC BRAKE



Removing Steps are as follow:

1. Remove the mounting bolt of disc brake clamp.
2. Remove the front brake oil pipe clamp.
3. Remove the front brake handle.
4. Remove the front cable panel.
5. Remove the front disc brake.

Installing Steps:

The installment should be carried out in the reverse order of removal.

NOTE: For KT250 model, remove the disc brake cover first.

REMOVING OR INSTALLING THE FRONT SHOCK ABSORBER



Removing Steps as follows:

1. remove the front disc brake.
2. Remove the front wheel.
3. Loosen the mounting bolt on the linkage.
4. Remove the front shock absorber.

Installing Steps:

The installment should be carried out in the reverse order of removal.

REMOVING OR INSTALLING THE LINKAGE



Removing Steps are as follows:

1. Remove the front shock absorber
2. Remove the lock nut of the steering column
3. Remove the upper link board
4. Remove the adjusting nut of the steering column
5. Take out the lower link board
6. Remove the steering column
7. The installation is carried out in the reverse order of removal

Installing Steps:

The installment should be carried out in the reverse order of removal.

CHECK THE FRONT STEERING

Check the front steering steps are as follows:

1. Aerial the whole vehicle
2. By turning the handlebar left to right to control the motorcycle head, if it turns smoothly and there is no obstruction, the motorcycle head turning is normal
3. If you find that the steering of the front of the car is obstructive, remove the link plate to check whether the steering bearing is normal.

LUBRICATION AND INSTALLATION OF STEERING HEAD BEARING



When installing the steering bearing on the head, apply a layer of lithium-based grease on the surface of the roller.

Refer to the figure on the left for specific installation.

REMOVING OR INSTALLING FRONT HEADLIGHT



Fixing Bolts on Upper Bracket

Removing Steps are as follows:

1. Remove the fixing bolts of the upper bracket
2. Remove the headlight
3. Pull out the connector between headlight and main cable

Installing Steps:

The installment should be carried out in the reverse order of removal.

REMOVING OR INSTALLING THE FRONT FENDER



Removing Steps are as follows:

1. Remove the fix screw.
2. Pull out the Front Fender.

Installing Steps:

The installment should be carried out in the reverse order of removal.

REMOVING OR INSTALLING THE REAR SHOCK ABSORBER



Check the rear shock absorber whether the airbag is normal and the spring is cracked or not, etc. If necessary, replace the rear shock absorber.

Please follow the steps below to removing the rear shock absorber:

1. Remove the muffer tube (see the exhaust system inspection section for details).
2. Remove the mounting bolts of the rear shock absorber and the frame.
3. Loosen the connecting bolts of the U-shaped rocker arm and the triangular rocker arm (do not remove it);
4. Remove the connecting bolts between the rear shock absorber and the triangular rocker arm;
5. After confirming that there is no interference, take out the rear shock absorber from the side;

Perform the Installation in the reverse order of removal.

REMOVING OR INSTALLING THE SEAT CUSHION

Removing Steps are as follows:

1. Remove the fixing bolt on both sides of the rear seat.
2. Take out the seat backwards.



Installing Steps:

The installment should be carried out in the reverse order of removal.

NOTE: For KT50, you also need to remove fixing bolt between the seat cushion and rear fender (with a 13mm wrench);

For KT85, you need to remove the fixing screws between the rear of the seat cushion and rear fender only, as there are no fixing screws on each side.

REMOVING OR INSTALLING THE AIR FILTER HOUSING



Removing Steps are as follows:

1. Remove the seat cushion.
2. Remove the rear side cover.

Installing Steps:

The installment should be carried out in the reverse order of removal.

NOTE: KT250 adopts a unique tool-free maintenance design. The side cover of the air filter can be removed or installed from the main body of the cover only by hands.

REMOVING OR INSTALLING THE AIR FILTER

Removing Steps are as follows:

1. Remove the air filter housing.
2. Loosen the connection between the air filter hose and the carburetor.
3. Remove the air filter sponge and its bracket.
4. Remove the air filter hose.

Installing Steps:

The installment should be carried out in the reverse order of removal.

NOTE: The removal of KT50 air filter hose and air filter housing depends on specific conditions.

CLEANING AND MAINTENANCE OF AIR FILTER



Before performing maintenance on the air filter parts, it is necessary to check first, the contents of which are as follows:

1. Check whether there are cracks on the surface of the air filter hose.
2. Check whether the air filter sponge is damaged.
3. Check whether the air filter sponge support is damaged.
4. Check whether there is a rupture problem in the air filter housing.

If the air filter is damaged, replace the corresponding parts; if no parts are damaged, perform maintenance as follows:

1. Clean the air filter hose with water and let it air dry.
2. Clean the dust attached to the air filter sponge and soak the surface with air filter oil. If the dust on the sponge is difficult to resolve, you can also replace a new air filter sponge.
3. Clean the surface of the air filter sponge support, let it dry naturally, and then apply a layer of oil on the surface.
4. Rinse the housing of the air filter with water and let it dry naturally.

REMOVING OR INSTALLING THE EXHAUST PIPE



Removing steps as below:

1. Remove the muffler tube
2. Remove the fixing bolts of the exhaust pipe
3. Remove the fixed spring of the exhaust pipe
4. Remove the fixing nut at the connection of the engine exhaust pipe
5. Remove the exhaust pipe

Installing Steps:

The installment should be carried out in the reverse order of removal.

REMOVING OR INSTALLING THE MUFFLER TUBE



The exhaust pipe and the muffler tube can guide the gas emission and reduce the noise.

If the exhaust pipe is rusty or ruptured or damaged by impact, please replace it with a new one immediately. If the noise is too high or the engine performance is degraded, replace the muffler tube.

For the cleaning of the exhaust system, please consult with KAYO dealers before operating.

If you need to replace the muffler tube, please follow the steps below:

- ◆ Unscrew the mounting bolts of the muffler tube
- ◆ Unscrew the fixing bolts of the muffler tube
- ◆ Loosen the buckle at the connection between the muffler tube and the exhaust pipe
- ◆ Pull out the muffler tube backwards
- ◆ Replace the muffler tube and install the fasteners

Installing Steps:

The installment should be carried out in the reverse order of removal.

REMOVING OR INSTALLING THE FUEL TANK



Installation screw

Removing steps as below:

1. Remove the seat cushion.
2. Remove the water tank.
3. Remove the front left and right guard plates.
4. Unscrew the fuel tank installation screws.
5. Remove the fuel tank from the frame.

Installing Steps:

The installment should be carried out in the reverse order of removal.

CHECK AND CLEAN THE CHAIN



Checking Steps are as follows:

1. Observe the chain from the rear of the vehicle to check whether the chain is skewed as a whole
2. Rotate the rear wheel by hand and observe whether the rotation of the rear wheel is smooth
3. Carefully check the gap between the chains to see if there is any sediment attached

Clean the Chain:

Use a special cleaning detergent to wash the surface, slit and gap of the chain; wait until the chain is naturally air-dried, and then apply a layer of anti-rust oil on the surface of the chain.

REMOVING OR INSTALLING THE CHAIN



Removing the Chain:

1. Remove the spring leaf on the chain.
2. Remove the movable section of the chain.
3. Pull out the chain from the sprocket.

Installing Steps:

The installment should be carried out in the reverse order of removal.

CHECK AND ADJUST THE CHAIN TENSION



The chain can transfer the output-power from the engine to the wheels, so that the motorcycle can move normally. It is an important part of the motorcycle. Therefore, the chain needs frequent inspection and maintenance to ensure its normal use.

The chain tension can be adjusted according to requirements, the steps are as follows:

1. Stand the motorcycle with rear wheel suspended.
2. Measure the distance between the rear fork and the chain. The normal distance should be 30-40mm, which is about the length of two fingers. It is not necessary to strictly demand it, within the normal distance is ok.
3. Loosen the rear axle nut;
4. Find the specific position with the greatest tension on the chain when the distance is within the normal range.
5. By using the notches on the tensioner and the lugs on the adjuster, through the nut on the tensioner, adjust the fork properly.
6. Tighten the tensioner nut.
7. Tighten the rear axle nut.
8. Check the point of maximum tension and re-adjust the tension if necessary.

When checking the chain tension, you should also check the chain guide and sprocket through visual inspection not limited to chain.

When the chain is over-used, or the stretch exceeds 2%, the chain should be replaced, and change the relevant guide rail and sprocket at the same time. If only replace the chain without replacing other accessories, the new chain will be easy worn out due to the worn accessories and shorten the service life, meanwhile these accessories will quickly reach the limit of use and must be replaced.

Therefore, even from an economic point of view, it is worthwhile to replace the entire chain drive system at the same time.

At any time, you should use the original parts from KAYO factory or the ones authorized by KAYO.

The chain needs to be lubricated regularly, see the lubrication section for details.

NOTE: The alternating wet and dry working environment will greatly shorten the service life of the chain and its surrounding accessories. Therefore, please follow the correct lubrication method and select a suitable lubricant for lubrication.

NOTE: If the chain needs to be tightened frequently, or if you find any signs of wear on the front sprocket, rear sprocket and the chain, please contact KAYO dealer for a thorough inspection to avoid safety problems.

ZHEJIANG KAYO MOTOR CO., LTD.

CHECK THE STRUCTURE OF THE REAR SPROCKET, ENGINE SPROCKET AND GUIDE CHAIN



Check the worn condition of the chain guide and the chain protector on the rear fork. Under normal circumstances, these two parts play a role in guiding the movement of the chain, the over-worn will affect the transmission function and thereby be harmful to normal movement of the chain.

Therefore, you must change the over-worn chain guide and chain protector in order to ensure that the motorcycle works normally.

CHECK THE FRAME

Checking Steps are as follows:

1. Check whether the paint layer on the surface of the frame is damaged or not.
2. Check whether the fixed points of the frame are deformed or not, especially the installation points of the engine, flat fork and rear shock absorber.
3. Check whether there are cracks on the surface of the frame, especially at the welded point.

CHECK THE FORK



Checking Steps are as follows

- 1 Check whether there are cracks on the surface of the flat fork
- 2 Check whether there is any deformation at the mounting point of the cradle on the flat fork
- 3 Check whether the surface paint of the flat fork is damaged or not.

CHECK THE THROTTLE CABLE



Checking Steps are as follows:

- 1 Turn the throttle knob to observe whether the throttle rebounds properly.
- 2 Start the engine, observe the engine power changing when turn the head from side to side, if there is any difference, it indicates that the throttle line is too short.

CHECK THE STEERING HANDLE



You could sit on the vehicle, rest your hands on the handlebars naturally, and feel whether the position of the clutch grip and brake grip are comfortable or not. If you feel difficult to steering, adjust the positions of the clutch and brake levers.

ADJUST THE POSITION OF THE CLUTCH HANDLE



The clutch position can be adjusted according to the customer's wishes:

By adjusting the screw, the distance between the clutch handle and the grip can be changed.

This setting does not change the internal structure of the clutch, therefore cause not affect the normal use of the clutch.

CHECK THE FLUID LEVEL OF THE HYDRAULIC CLUTCH / REPLENISH THE TRANSMISSION FLUID



Observe hole

KT85 uses a hydraulic clutch, and its liquid level needs to be checked frequently.

The inspection steps are as follows:

1. Check the liquid level of the clutch transmission fluid through the observation hole. The liquid level should not be lower than the minimum liquid level, that is, half of the observation hole.
2. Pinch and release the clutch grip with your hands. If the grip feels soft, check whether the transmission fluid pipe is leaking. If there is a leak, replace the hydraulic clutch.



If the fluid level of the clutch transmission fluid is lower than or equal to the minimum fluid level, you need to replenish the transmission fluid, the steps are as follows

1. Unscrew the fixing screw of the oil cap.
2. Remove the oil cap.
3. Refuel fluid to the maximum level
4. Put back the cap and re-fix the screws

CHECK AND MAINTENANCE THE BRAKE SYSTEM

CHECK THE FREE-PLAY OF FRONT BRAKE LEVER



Checking steps as below:

1. Rest your right hand on the right hand grip naturally
2. Use the index finger and middle finger of your right hand to check the free play. At this time, two fingers are required to be able to hook and pull the handle.
3. Pinch and release the handle and feel the resistance. If it feels soft, it seems that the air may be mixed into the oil pump or oil pipe. You should check the entire brake system and take measures accordingly.

CHECK THE CABLE OF FRONT BRAKE LEVER



The front brake lever can be adjusted to suit the different groups.

The adjustment steps are as follows:

1. Loosen the fixing nut.
2. Turn the adjusting nut to adjust the angle of the handlebar to the position you are satisfied with.
3. Turn back the fixing nut.

DANGER: You should test the brake system (including front brake and rear brake) every time the motorcycle starts. If you feel soft when you pinch the brake lever or step on the brake pedal, there may be air in the corresponding pump or oil circuit, or the corresponding One or more parts of the brake system are in poor condition. Once the above situation occurs, please check the brake system immediately and contact your KAYO dealer.

CHECK THE DISC BRAKE

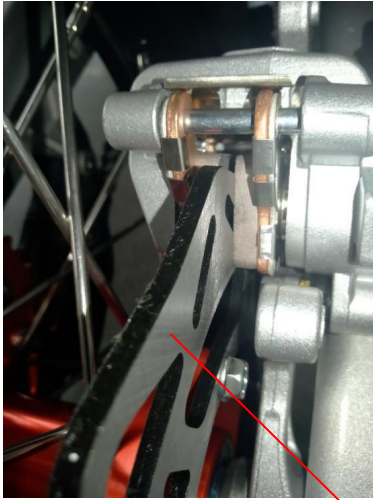

Brake disc

Checking Steps are as follows:

1. Check whether there are cracks, dents and other damages on the surface
2. Measure the thickness of the disc brake and compare it with the limit thickness required.
3. If the thickness of disc brake is less than or equal to the limit thickness of the disc brake, it must be replaced immediately.

The limit thickness table of disc brake is as follows:

	Limit thickness of Front Brake Disc	Limit thickness of Rear Brake Disc
KT250	2.5mm	3.5mm

CHECK THE FRONT BRAKE LIQUID LEVEL



KT250 uses hydraulic disc brakes, and you can check the liquid level through the observation hole.

If the liquid level is lower than the bottom edge of the observation hole, you should immediately refuel the fluid to the upper edge.

REFUEL THE FRONT BRAKE LIQUID LEVEL

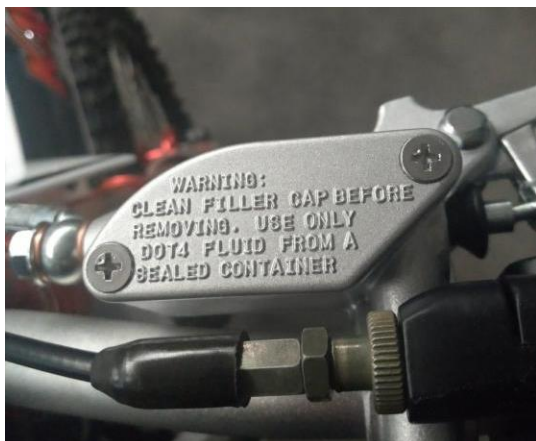

You should check/refuel the liquid level regularly. If the brake fluid is mixed with water, soil or other particles, the brake fluid should also be replaced. It is recommended to use DOT4 brake fluid. Danger: Do not mix different types of brake fluid and pour it into the brake system for use. The use of brake fluid must meet the braking requirements. Please do not use the brake fluid in an unsealed container. The brake fluid may deteriorate when exposed to the air, which will affect the braking effect. Do not use used brake fluid.

NOTE: You should change the brake fluid once a year, even it has not used for a long time.

CHECK THE FRONT BRAKE PADS



Check the thickness of the pads of brake caliper. You must change the pads if the thickness is less than the minimum thickness of the brake pads. The minimum thickness of the brake pad is 1mm.

NOTE: The brake pads should be replaced as a complete set. If you are not sure to complete the replacement work, please go to the KAYO dealer and have a professional to complete the replacement.

CHECK THE FREE-PLAY OF FOOT BRAKE



In normal use, the free-play of the brake pedal is shown in the table below.

Check the brake lever and pay attention to whether the stroke is correct.

Model	Free-Play
KT250	45~60mm

CHECK THE REAR BRAKE DISK LIQUID LEVEL



Check the Liquid level through the Observing Hole.
The liquid level should higher than minimum level as required.

You should refuel it if it is insufficient.

NOTE: Do not splash the brake fluid on the paint surface, which may cause corrosion.

DANGER: Please pay attention to check whether the brake fluid is leaking and whether the brake fluid pipe is damaged.

If so, please contact KAYO dealer.

REFUEL THE REAR BRAKE DISK LIQUID LEVEL



Refueling Steps are as follows:

1. Remove the screw.
2. Remove the cap.
3. Refuel brake fluid to a proper level.
4. Re-load the cap.

It is recommended to use DOT4 brake fluid.

CHECK THE REAR BRAKE PADS

Brake Pads

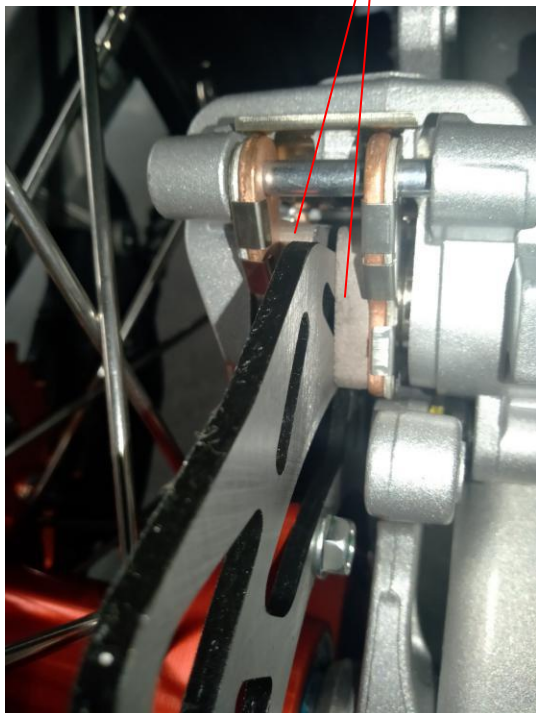

After checking the thickness of the brake pads of the brake caliper, the thickness should not be less than 1 mm. If the thickness of the brake pads is lower than the minimum thickness, the entire set of brake pads should be replaced immediately.

WARNING

DANGER: If it is found that the brake system is too worn, the corresponding parts should be replaced immediately to avoid safety accidents.

The specific work should be carried out after consulting the KAYO dealer.

TIRE INSPECTION AND MAINTENANCE

REMOVING OR INSTALLING THE FRONT WHEEL



Removing Steps are as follows:

- ◆ Lift the motorcycle off the ground and Stabilize it by using a motorcycle stand.
- ◆ Remove front disc brake cover if have,
- ◆ Loosen the front wheel axle pinch bolts
- ◆ Holding the front wheel with one hand, withdraw the front wheel axle gradually with another hand
- ◆ Remove the front wheel

Installing Steps:

The installment should be carried out in the reverse order of removal.

REMOVING OR INSTALLING THE REAR WHEEL



Removing Steps are as follows:

- ◆ Remove the chain.
- ◆ Loosen the rear wheel axle bolts
- ◆ Holding the rear wheel with one hand, withdraw the rear wheel axle gradually with another hand
- ◆ Remove the rear wheel

Installing Steps:

The installment should be carried out in the reverse order of removal.

TIRE INSPECTION

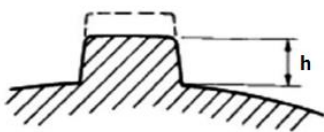

Checking Steps are as follows:

1. Check the tires if there are crosswise lines, if the tire has a nail or glass fragments in it, or if the sidewall is cracked.
2. Check the tire thread worn, if the height of tire plies lower than minimum require, replace the tire right away.

The minimum height requires: 3mm

ZHEJIANG KAYO MOTOR CO., LTD.

CHECK TIRE PRESSURE

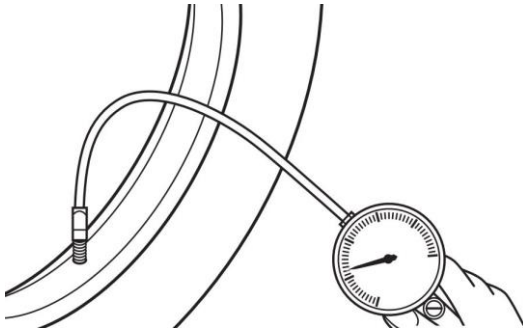

Check the tire pressure by using a pressure gage. If it happens frequently with lower pressure problem, find out if there is a deflation or not and contact the Kayo Dealer for help.

Pressure advice

	Front Tire	Rear Tire
KT250	225kPa	280kPa

NOTE: Do the checking work only on cold tires (i.e., when the temperature of the tires equals the ambient temperature).

CHECK SPOKE



spoke

Use your fingers to move the adjacent spokes to check whether the tire spokes lack tension. If you find that the spokes are loose and weak, you must check all the spokes and both wheels.

If there is any further problem, please contact the KAYO or KAYO dealer.

ELECTRICAL SYSTEM

REMOVING OR INSTALLING THE BATTERY



Removing Steps are as follows:

1. Removing the passenger seat
2. Disconnect cable from the battery
3. Remove the screw on battery holder
4. Pull the battery up and out.

Installing Steps:

The installment should be carried out in the reverse order of removal.

CHANGING THE BATTERY



If you found bubble appears in the surface of the battery or it needs frequent charging, you should change the battery.

The new battery should use KAYO original Battery or authorized one by KAYO.

The battery size: 112mm×69mm×85mm

MAIN CABLE

KT250 VEHICLE WIRING DIAGRAM

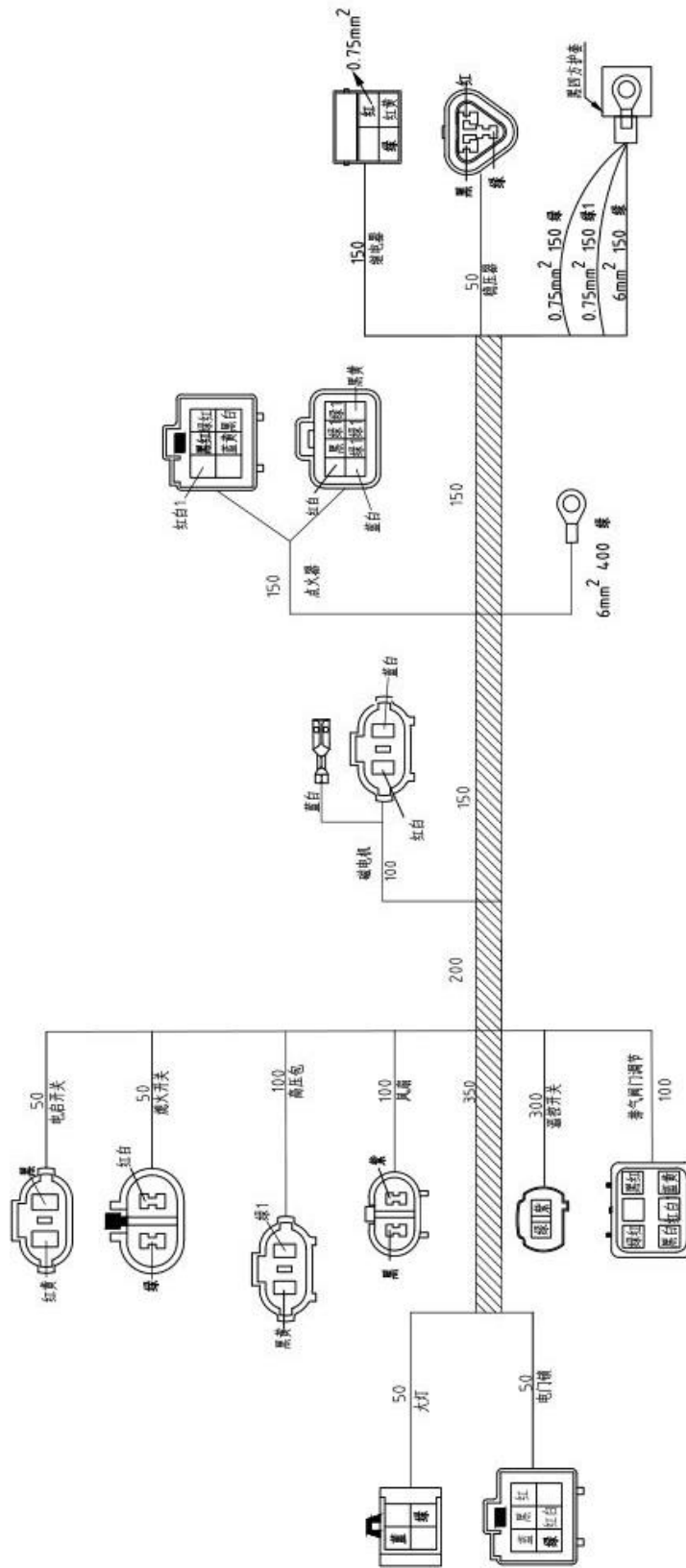

COOLING SYSTEM

COOLING SYSTEM PROFILE



The excess heat can be absorbed by antifreeze and be transferred to air through radiator.

If the antifreeze in the tank does not match the specified value, it can't work properly and thereby the motor may be overheated and damaged.

The antifreeze level should be checked before each ride to ensure its coolant work.

To prevent the metal parts in the cooling system from rust and erosion, the antifreeze must have chemical inhibitor. Otherwise, the antifreeze without inhibitor will hinder the coolant hose and effect the coolant work.

NOTE: We choose “Da Zhong Pet sun Antifreeze” in the first place which freezing point is -25°C .

WARNING: Antifreeze is a kind of chemical reagent and may cause problem to human body, pls read the instruction carefully before working.

WARNING: Using wrong antifreeze may cause damage to motor and cooling system. Pls choose the antifreeze with chemical inhibitor.

REMOVING OR INSTALLING THE COWLING AND HOSE



Check the antifreeze tank if it is cut or damaged, if there is still a leakage after connecting.

Check the tank if there is a congestion, rinse the dirt with low-press water.

NOTE: Do not use high-press water to do the wash, this may cause damage and effect the heat transfer.

What's more, do not install the unauthorized spare parts, which may disturb heat transfer and thereby damage the motor due to overheat.

CHECK ANTIFREEZE LEVEL



Max Level

- ◆ Stop and stand the motorcycle upright on a horizontal surface.
- ◆ Release the tank cap and let the hot steam spill out. Then open the cap to complete the disassembly.
- ◆ Sway the motorcycle from side to side and then check the antifreeze level, which should be between Min and Max.
- ◆ If the level does not match the specified value, correct the antifreeze level.

DRAIN OUT THE COOLANT

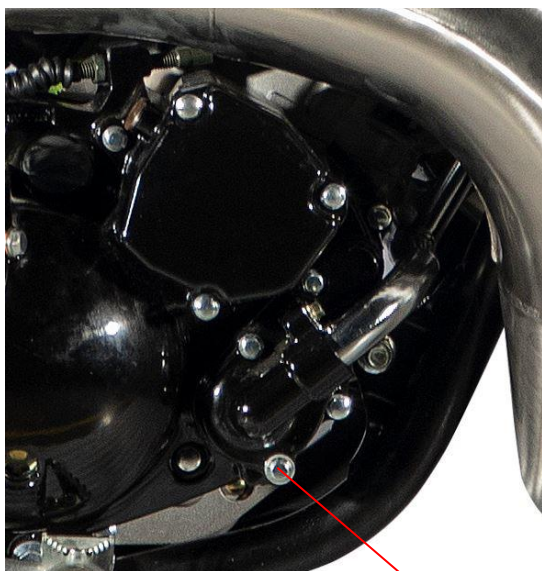

screw

You can drain the coolant out of the engine and cooling system through adjusting the screw.

Main work:

- ◆ Stand the motorcycle upright and allow the engine and coolant system to cool down.
- ◆ Place a suitable container under the screw, which is on the bottom of the water pump and is used to drain the coolant.
- ◆ Remove the screw. The coolant still can't be drain out at this time due to pressure problem.
- ◆ Remove the tank cap, make the air into the cooling system to drain the antifreeze.

NOTE: If the antifreeze drains out without remove the cap, it means that there must one or more air leakage and need to do an overall check.

FILLING THE COOLING SYSTEM



You should change the coolant regularly to increase service life.

Main work:

- ◆ Drain out the coolant. → p.50
- ◆ Mount the screw after draining the coolant completely.
- ◆ Fill in a little of coolant through water tank. Always check if there is leakage or not.
- ◆ Fill in the coolant to specific value.
- ◆ Start the engine for 5 minutes to heat that, then stop.
- ◆ Check the coolant level again after the engine cooled down. And correct the coolant level if necessary.
- ◆ Tighten the tank cap.

WARNING

DANGER OF SCALDING Do not remove the radiator cap, screw or other cooling system components when the engine is hot. Wait for the engine and cooling system to cool down.

If the coolant drops on the tire, it will cause the tire easy to slip and thereby cause the accident.

So, you should rinse the coolant which dropped onto the frame and tire.

You should check the drained-out coolant, if the liquid is white, it means the aluminum parts was corroded; if the liquid is brown, it means the steel or iron parts was corroded. Otherwise, it means the cooling system works well.

Check the seal ring, if there is any damage, change a new one.



ZHEJIANG KAYO MOTOR CO., LTD.

INTRODUCING ABOUT THE ENGINE STRUCTURE

1. AIR DISTRIBUTION MECHANISM

The timing driving sprocket on the crankshaft drives the timing driven sprocket on the camshaft through the chain to rotate the camshaft. The cam drives the rocker arm with the rotation of the camshaft, and the rocker arm overcomes the resistance of the valve spring to control the opening of the valve.

2. COOLING SYSTEM

KT250 uses coolant to cool the engine. The coolant enters the engine from the water tank through the water pipe, takes away the heat of the engine, flows back to the water tank, and then exchanges heat with the air. After the coolant cools down, it enters the engine again to play a cooling role.

INSTALLING THE ENGINE

The installation steps are as follows:

1. The engine is suspended on the frame (pay attention to protect the appearance of the engine).
2. Install the carburetor on the intake elbow and fasten it with nuts and bolts.
3. Install the throttle cable and air filter, the interface should be sealed, and the clutch control cable should be installed.
4. Install the transmission chain.
5. Install the left rear cover or sprocket guard and fasten it with bolts. Pay attention to the outgoing wire of the magneto.
6. Install exhaust muffler. The M8 nut and the exhaust pipe sealing ring should be installed firmly with a tightening torque of 10~15N•m, and the exhaust port should not leak air during installation.

ENGINE MAINTENANCE AND ADJUSTMENT

Inspection of installation bolts and nuts of cylinder head and cylinder block

The inspection is carried out at the first 1000km and every 5000km. When the engine is cold, use a torque wrench to tighten the bolts and nuts to the specified torque.

TORQUE	M8	28~32N.m
	M6	10~15N.m

CHECK THE VALVE CLEARANCE

The inspection is carried out at the first 1000km and every 5000km. Excessive valve clearance will cause valve noise, and too small valve clearance will cause engine power drop and valve damage. The valve clearance should be checked according to the above prescribed mileage, and the valve clearance should be adjusted according to the following procedures:

- ◆ Remove the valve cover.
- ◆ Unscrew the magneto plug and timing screw plug on the left front cover, and use a 14mm socket wrench to turn the magneto rotor until the piston reaches the top dead center of the compression stroke (turn the magneto rotor until the engraved line on the rotor matches the left front cover Until the timing holes on the top are aligned).
- ◆ Insert a standard feeler gauge between the end of the valve rod and the adjusting screw on the rocker arm. The clearance between the intake and exhaust valves is 0.03~0.05mm.
- ◆ If the valve clearance is not within the above range, use a special tool to adjust it within the

ZHEJIANG KAYO MOTOR CO., LTD.

specified range.

- ◆ Reinstall the valve cover, magneto plug and timing plug.

NOTE: The valve clearance should be checked and adjusted when the engine is cold.

COMPRESSION PRESSURE CHECK

The inspection is carried out for the first 1000km and every 5000km.

The inspection steps are as follows:

1. Let the engine run at idle speed and warm it up.
2. Unscrew the spark plug.
3. Install the pressure gauge and connector into the spark plug mounting hole and make sure that the connection is firm.
4. Turn the throttle handle to the fully open position.
5. Start the engine several times with the starter motor and read the pressure gauge to show the highest-pressure value of the engine cylinder.

Standard	1200~1250Pa
Minimum	1100Pa

Low pressure indicates the following faults:

- ◆ Excessive wear of the cylinder wall.
- ◆ The piston or piston ring is worn.
- ◆ The piston ring is stuck in the ring groove. The valve is not properly engaged with the valve seat.
- ◆ The cylinder head gasket is damaged. When the engine compression pressure is lower than the above limit value, the engine should be reinstalled, inspected and repaired according to the specific conditions.

NOTE: Before testing the compression pressure of the engine, make sure that the cylinder head nuts and bolts are tightened according to the specified torque and the valve clearance is adjusted correctly.

ADJUSTMENT OF CLUTCH CONTROL SYSTEM

In order to ensure that the clutch can be used correctly and the portability of operation, the user should ensure that the clutch is in the engaged state in the normal state when adjusting, and is never allowed to be in the half-clutch state.

THE ENGINE ADJUSTMENT

IDLE SPEED ADJUSTMENT OF CARBURETOR

Throttle screw



Air screw

The idle speed of the carburetor can be adjusted through the throttle screw and air screw.

Proceed as follows:

1. Rotate the air screw clockwise until it reaches the top of its stroke, and then reverse one and a quarter of a turn;
2. Adjust the throttle screw to ensure that the engine can run at a certain speed when the throttle lever is completely loosened;
3. Adjust the throttle screw to reduce the engine speed as much as possible;
4. Adjust the air screw to increase the engine speed as much as possible;
5. Repeat the above steps until a satisfactory speed is obtained;
6. Check whether the throttle cable is working properly.

DANGER: Driving a motorcycle with a damaged throttle cable is undoubtedly a very dangerous behavior. The normal throttle cable should have a free stroke of at least 10mm. Start the engine and turn the handlebar left and right. If the engine stalls or accelerates due to the movement of the handlebar, the throttle cable may be improperly adjusted or damaged. Make sure that the throttle cable is normal before driving the motorcycle.

CLEAN THE CARBURETOR

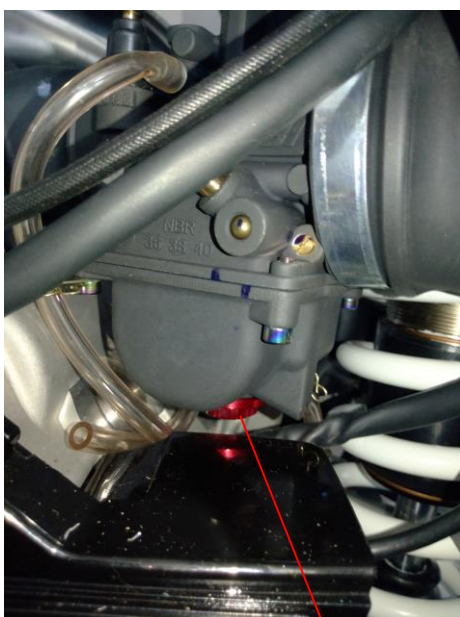

KT250 carburetor oil drain bolt

The carburetor will leave a portion of fuel after every ride. Therefore, the carburetor should be cleaned after each ride to avoid the generation of grease stains and affect the use of the carburetor.

The cleaning steps as follows:

1. Place a container under the carburetor for receiving fuel
2. Turn off the fuel tank switch
3. Unscrew the drain bolt of the carburetor and wait for the fuel to flow out
4. After the fuel is drained, screw the drain bolt back

CHECK THE SHIFT LEVER POSITION

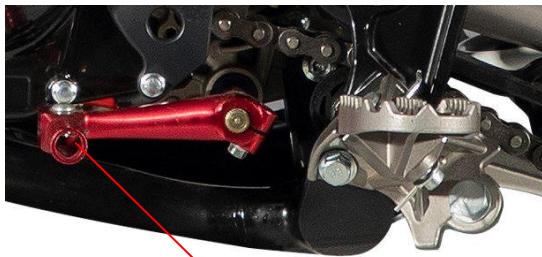

Shift Head

The inspection steps are as follows:

1. Raise the whole vehicle so that the center plane of the tire is perpendicular to the ground
2. The line of sight is level with the tread surface, and observe the position of the shift head
3. The shift head should be level with the tread surface or slightly lower than the tread surface

If the shift head is higher than the tread surface, the shift head should be adjusted downwards; if the shift head is excessively lower than the tread surface, the shift head should be adjusted upwards.

ADJUST THE SHIFT LEVER POSITION



Shift lever fixing bolt

Adjusting Steps are as follows:

1. Loosen the fixing bolts of the shift lever.
2. Remove the shift lever.
3. Turn the shift lever to a suitable position and install the spline.
4. Tighten the shift lever fixing bolt.

INSPECTION OR REPLACEMENT OF SPARK PLUGS



The engine spark plug torque is 25~30N•m.

The spark plug must be disassembled regularly to check the distance between the electrodes (0.6 ~ 0.7 mm). If the spark plug contains oil or cinder, wipe it off with a wire brush or similar. Use a measuring instrument to measure the distance between the electrodes and adjust them to prevent abnormal bending of the external electrodes. If the spark plug electrode is rusty, damaged, or the insulator is broken, the spark plug must be replaced.

NOTE: The spark plug should be checked every 10 hours accumulated and replaced every 20 hours accumulated.

NOTE: If the engine performance drops, replace the spark plug to restore normal performance.

LUBRICANT SELECTION

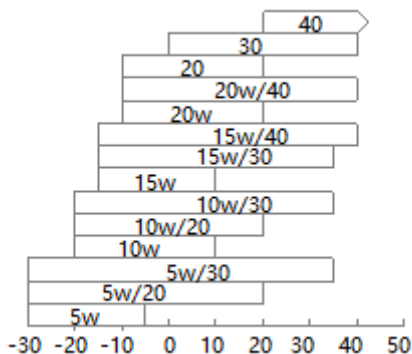

Lubricating oil is an important factor affecting the performance and life of the engine. It must be selected according to regulations. It is forbidden to replace it with ordinary engine oil, gear oil, vegetable oil, etc.

When the car leaves the factory, 15W/40-SF grade gasoline is filled in the transmission box. If you change to other lubricating oil, its quality level should reach SG level or above, and the viscosity should be selected according to the attached drawings according to different regions and temperature changes. When replacing the lubricating oil, please drain the original lubricating oil in the crankcase and clean it with washing kerosene before adding new lubricating oil according to the regulations.

The thermal engine system of this engine must be lubricated with two-stroke special engine oil. The engine oil is mixed with gasoline and enters the carburetor. It is atomized with the fuel mixture to form oil mist and enter the crankcase, thereby lubricating the crankshaft, cylinder block and piston parts.

LUBRICANT INSPECTION



Lubricant Observation Window

If the engine is running, turn off the engine and wait a few minutes for the oil to reach the bottom of the crankcase. Place the engine vertically on the ground and observe through the oil observation window. The oil level should be between the upper and lower scales of the observation window.

If the oil level is higher than the upper graduation line, the excess oil should be discharged.

If the oil level is lower than the lower mark, you should add lubricating oil.

LUBRICANT REPLACEMENT



When replacing the lubricating oil, it should be done before the engine is warm and has not yet cooled, so as to ensure that the lubricating oil in the crankcase can be discharged quickly and completely. When replacing, place an oil pan under the engine and unscrew the oil bolt A to release the lubricating oil. Check the plug gasket for damage, and replace it with a new one if it is damaged. When the lubricating oil is completely discharged, install and tighten the oil drain bolt and gasket. The tightening torque is: 15~20N·m. Refill with new lubricating oil and check the oil position.

REMOVAL OR INSTALLING THE OIL PUMP

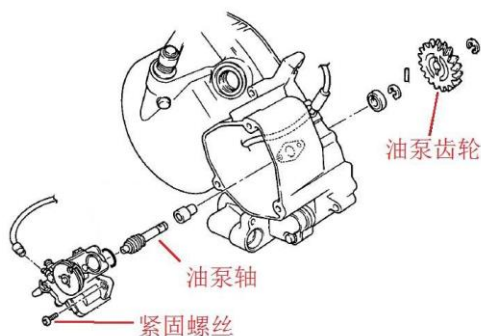

The two-stroke oil pump is related to the effective lubrication of the engine piston, cylinder block, crankshaft and other thermal parts, so the inspection of the oil pump is particularly important.

The lubrication of the heat engine part of the KT250 model engine must be a special two-stroke engine oil by mixing gasoline into a special burning oil. Adjust the opening of the oil pump according to the throttle to mix a proper proportion of the burning oil. A proper proportion of combustion oil can lubricate the piston, cylinder block, crankshaft, connecting rod, etc., and effectively protect the engine.

When disassembling the oil pump, first remove the oil pump cover on the right cover of the engine, and then remove the two fastening screws of the oil pump to remove the oil pump. When reinstalling, install it in the reverse order of the removal.

NOTE: The tightening torque of the oil pump screws is 5N.m.

OIL PUMP INSPECTION

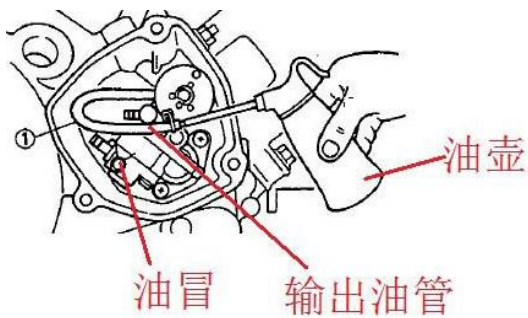

After the oil pump is installed, the oil pump needs to be drained and filled. As shown in the figure on the left, insert the nozzle of the oil can into the output pipe of the oil pump, remove the oil cap, and then fill the oil. Until the oil drips at the installation location of the oil pump (at the bottom of the oil pump), finally install the oil cap, and then install the output oil pipe to the carburetor.

COMMON PROBLEMS AND CAUSES OF LUBRICATION SYSTEM

PERFORMANCE	REASON
Lubricating oil consumes too fast	engine oil leakage
The lubricating oil is not clean	The lubricating oil is not changed regularly
	The corresponding lubricating oil is not used as required

REMOVAL OF THE COOLING PUMP



The removal steps of the cooling pump are as follows:

1. Place a container under the engine, unscrew the engine drain bolt A, and release the coolant in the engine.
2. Unscrew the fastening bolts B, C, D of the water pump cover.
3. Remove the cooling pump cover.
4. Remove the cooling pump impeller.

Check whether the impeller is damaged, the cooling water seal is moving, and the static ring sealing surface is abnormally worn or strained. If it is damaged, it needs to be replaced.

Check whether the end face of the cooling pump cover is damaged or not. Replace accordingly if damaged.

INSTALLATION OF COOLING PUMP



The installation steps of the cooling pump are as follows:

1. Press the water seal static ring of the cooling pump to the right cover.
2. Install the cooling pump impeller into the right cover, and then install the cooling pump gear.
3. Lock the cooling pump gear.



4. Install the cooling pump cover

NOTE: Sealant needs to be applied to both sides of the paper pad of the cooling pump cover.

NOTE: The tightening torque of the cooling pump cover bolts is 10~15N.m.

ENGINE CYLINDER BLOCK AND PISTON

CYLINDER BLOCK AND PISTON PARTS SPECIFICATIONS

ITEM		STANDARD (mm)	Repair Limit Value (mm)
CYLINDER BLOCK	Cylinder hole diameter	66.80~66.818	66.878
PISTON	Piston outer diameter	66.752~66.767	66.602
	Piston pin hole inner diameter	16.004~16.015	16.042
	Width of the bottom of a ring groove	0.86~0.875	0.96
	Width of the bottom of the second ring groove	1.21~1.23	1.31
LINKAGE	Small head aperture diameter	21~21.008	21.04
PISTON PIN	Outer diameter	15.994~16.000	15.96
CYLINDER AND PISTON CLEARANCE		0.033~0.066	0.123
PISTON PIN HOLE AND PISTON PIN CLEARANCE		0.004~0.021	0.022
PISTON RING THICKNESS	The outer edge thickness of a ring	1.17~1.19	1.1
	Outer edge thickness of second ring	1.17~1.19	1.1
CLEARANCE BETWEEN PISTON RING AND RING GROOVE	First ring	0.02~0.04	0.14
	Second ring	0.02~0.07	0.17

REMOVAL OF CYLINDER BLOCK

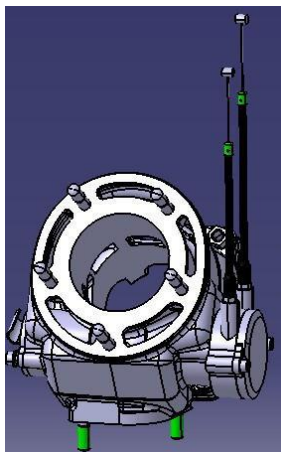

The cylinder block removal steps are as follows:

1. Remove the cylinder head.
2. Remove the cylinder head gasket.
3. Remove the cylinder block.

NOTE: When removing the cylinder, the cylinder block positioning pin cannot fall into the crankcase.

4. Scrape the remaining paper pad on the cylinder surface with a scraper.

NOTE: If the paper pad is immersed in gasoline, it is easy to disassemble. When doing this work, avoid damaging the cylinder contact surface.

CYLINDER BLOCK INSPECTION

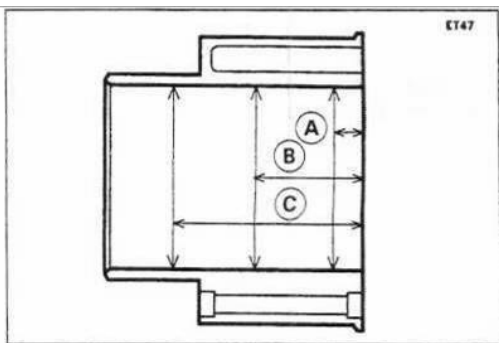

Check whether the cylinder is worn or damaged.

To measure the inner diameter of the cylinder, three positions should be measured, namely the top A, the middle B and the bottom C of the piston stroke, and the two directions should be at right angles to each other.

A=10 B=60 C=100

Standard value of cylinder bore: 66.8~66.818

REMOVAL OF PISTON



Remove the piston pin retaining ring with pliers

NOTE: Do not drop the retaining ring into the crankcase.

Press the piston pin out of the piston, and then remove the piston.

PISTON AND
PISTON RING INSPECTION



Use thickness gauge A to measure the gap between the piston ring and the groove of the piston ring.

Measurement standard value:

The first ring: 0.02~0.04

The second ring: 0.02~0.06

Remove the piston ring.

NOTE: When disassembling, do not damage the piston ring.

Check whether the piston has abnormal wear or cracks, and whether the piston ring groove has abnormal wear.

CLEANING AND INSPECTION OF
CYLINDER HEAD

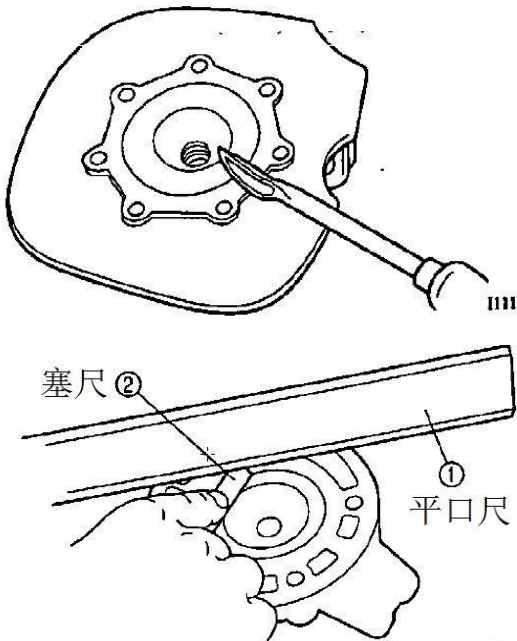

Clean the carbon in the combustion area of the removed cylinder head. If there is carbon deposits, use a small scraper to remove the carbon deposits. Then use a flat ruler and feeler gauge to measure the flatness of the cylinder head mounting surface. It is required to be within 0.03mm.

CHECK THE CLEARANCE BETWEEN CYLINDER AND PISTON

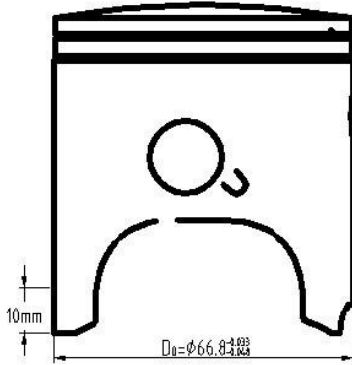

Measure the outer diameter 10mm above the bottom end of the piston skirt.

Standard value: 77.950~77.97

Calculate the gap between the cylinder and the piston.

MEASURE THE DIAMETER OF PISTON PIN AND PIN HOLE

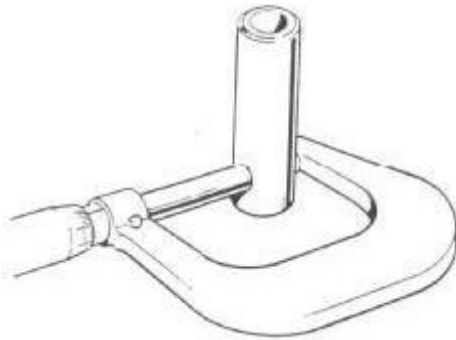

Measure the diameter of the piston pin hole:

Standard value: 17.002~17.008

Measure the outer diameter of the piston pin:

The standard value is: 16.994.0~17.000

INSTALLATION OF PISTON RING

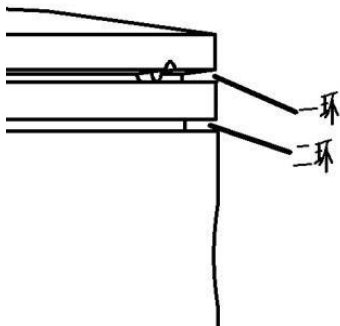

The installation steps of the piston ring are as follows:

1. Thoroughly clean the piston ring groove.
2. Install the piston ring.

NOTE: During installation, the piston and piston ring should be prevented from being damaged.

When installing the piston ring, the side with the mark is facing up. After installation, the piston ring should be loose and flexible. Do not reverse the installation positions of the first ring and the second ring. The first ring is black and the second ring is silver.

Precautions when installing the piston ring:

The opening of one ring faces the pin position of the other ring;

The opening of the second ring faces the pin position of the second ring.

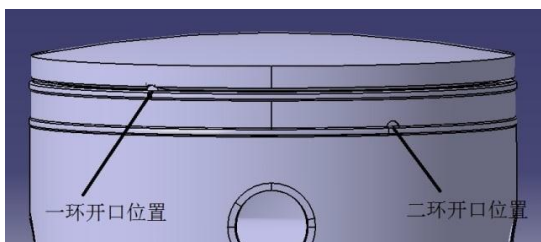
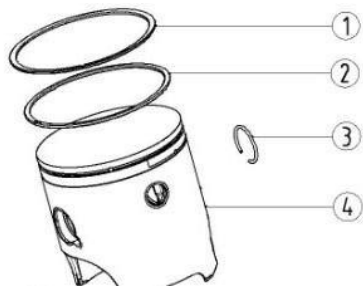

INSTALLATION OF PISTON

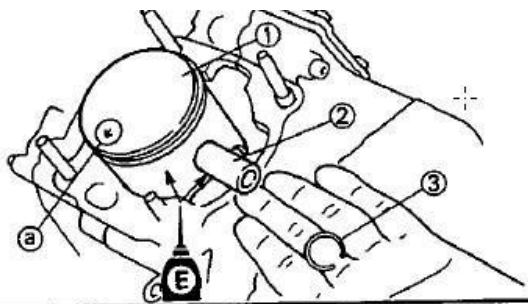

Install the piston, piston pin and new piston retaining ring.

NOTE: When installing the piston, the side with the mark "▲" should be aligned with the direction of the exhaust pipe. The end clearance of the piston pin retaining ring should be staggered with the piston cutout. When assembling after disassembly, be sure to use a new piston pin retaining ring. Do not allow the piston pin retaining ring to fall into the crankcase.

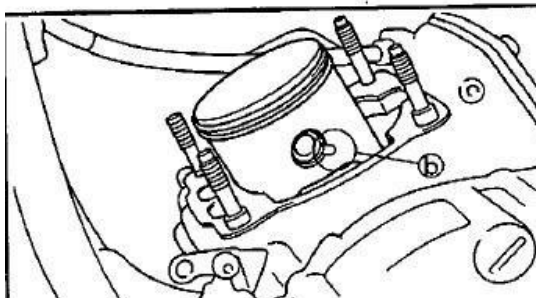

INSTALLATION OF CYLINDER BLOCK



The installation steps of the cylinder block are as follows:

1. Install the new paper pad and positioning pin.
2. Coat the cylinder and piston ring with a layer of oil.
3. Install the cylinder.

The tightening torque of cylinder block nut: $24 \pm 2\text{N.m}$

NOTE: When installing, avoid damaging the piston. Do not let the positioning pin fall into the box.

4. Install the cylinder head gasket
5. Install the cylinder head

The tightening torque of the cylinder head nut: $24 \pm 2\text{N.m}$

REMOVAL OR INSPECTION OF CLUTCH

CLUTCH PARTS SPECIFICATIONS

ITEM		STANDARD (mm)	REPAIR LIMIT VALUE (mm)
CLUTCH	Free Move	2~3	/
	Active friction plate thickness	2.95~3.05	2.7
	Driven friction plate thickness	Maximum flatness 0.1	0.2
	Free height of main spring	35.5	34

REMOVAL OF THE RIGHT CRANKCASE COVER



The steps for removing the right crankcase cover are as follows:

1. Drain the engine oil.
2. Release the coolant.
3. Loosen the connecting bolt of the right crankcase cover.
4. Remove the right crankcase cover.

REMOVAL THE CLUTCH

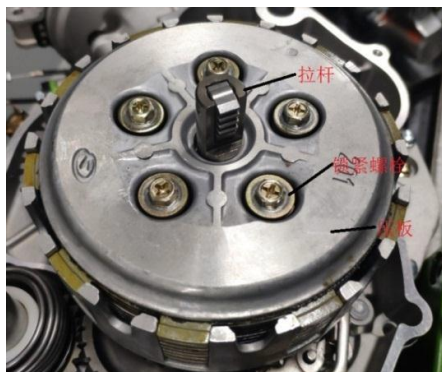

The clutch disassembly steps are as follows:

1. Remove the locking bolt of the clutch friction plate.
2. Remove the clutch friction plate pressure plate and pull rod.
3. Loosen the clutch lock nut.
4. Remove the clutch assembly.
5. Remove the spline washer and clutch bushing.
6. Remove the clutch cover.
7. Remove the elastic washer and flat washer.

CLUTCH INSPECTION

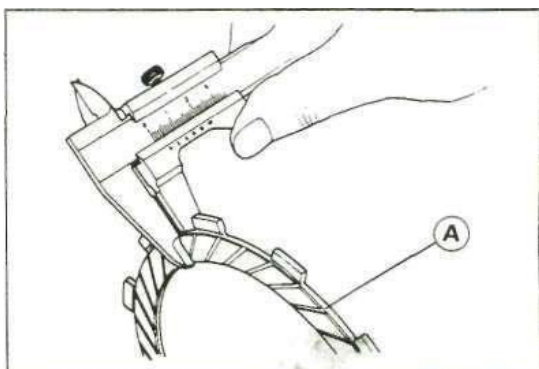

Vernier caliper to check the thickness of the active friction plate:

Standard value: 2.95~3.05

Repair limit value: 2.7

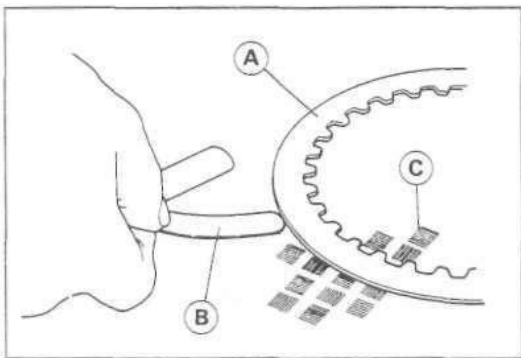

Use a thickness gauge to check the flatness of the driven friction plate

Standard value: ≤ 0.1

Repair limit value: 0.2

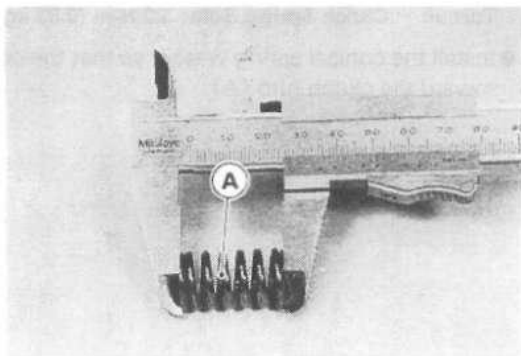

Vernier caliper to check the free height of the clutch spring

Standard value: 35.5

Repair limit: 34

INSTALLATION OF CLUTCH



The clutch installation steps are as follows:

1. Install driven gear and balance gear.
2. Install driven tooth flat key and balance tooth flat key.
3. Install balance tooth lock washer and driving tooth washer.
4. Install balance tooth lock nut and driving tooth bolt.

NOTE: The torque of the clutch tightening nut is $90 \pm 5 \text{N.m}$

The tightening torque of the driving tooth bolt is $70 \pm 5 \text{N.m}$

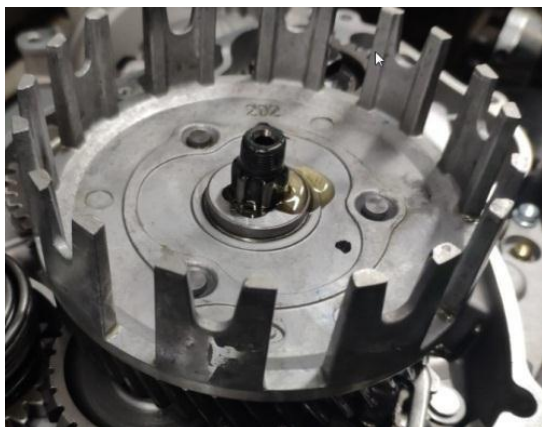

5. Install the clutch flat washer and elastic washer.
6. Install the clutch cover.
7. Install center spline.



8. Installation center set combination
 9. Install the clutch lock nut gasket (concave face down)
 10. Install the clutch lock nut (chamfered face down)
- The installation torque is: (70~80) N·m
11. Install the clutch cover
 12. Install bearings, flat washers and push rods
 13. Install cover springs and bolts

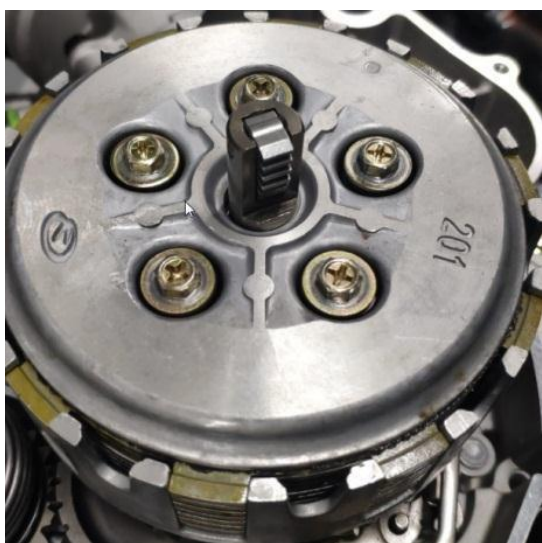

NOTE: The bolt tightening torque is 8N.m

NOTE: When installing the lock nut gasket of the clutch, the concave surface of the gasket should face the clutch.

INSTALLATION OF THE RIGHT CRANKCASE COVER



The installation steps of the right crankcase cover are as follows:

1. Install positioning pins and new sealing paper pads.
2. Install the right crankcase cover.
3. To install the fastening screws, first tighten the bolts at the positioning pin holes, and then tighten the remaining bolts crosswise. The installation torque is: 8~12N·m.
4. Install the oil drain bolt and copper washer, the installation torque is: 15~20N·m.

REMOVAL OR INSTALLATION OF THE SHIFT MECHANISM IN THE ENGINE



The disassembly and assembly steps of the shift mechanism are as follows:

1. Remove the clutch assembly.
2. Pull out the shift arm.

Check whether the shift arm has any deformation and wear that affect the use.

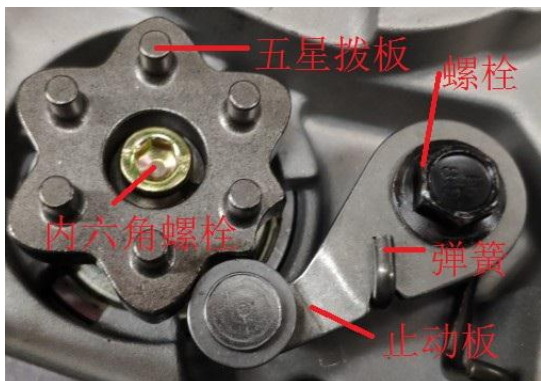

3. Loosen the fastening bolts of the stop plate.
4. Remove the stop plate.
5. Loosen the hexagon socket bolt.
6. Remove the five-star dial.



7. Remove pins.

Installation is carried out in the reverse order of removal.

NOTE: the installation pin should prevent it from falling.

Torque of hexagon socket head bolt: (10~15) N•m

Fastening bolts of stop plate: (10~15) N•m

When installing the shift arm, the limit shaft needs to be installed in the corresponding position.

Shift the shift arm to neutral, confirm that it is flexible and has a sense of position.

MAGNETO AND ELECTRIC STARTING PARTS OF ENGINE

REMOVAL OR INSTALLATION OF STARTER MOTOR



The removal steps of the starter motor are as follows:

1. Remove the motor mounting bolt A
2. Remove the starting motor

Installation is carried out in the reverse order of removal.

REMOVAL OR INSTALLATION OF LEFT CRANKCASE COVER



The disassembly and assembly steps of the left front cover are as follows:

1. Remove the mounting bolts of the left front cover.
2. Remove the left front cover.
3. Remove the sealing paper pad.
4. Remove the positioning pin of the left front cover.

NOTE: Do not damage the joint surface of the cover when removing the left front cover.

Installation is carried out in the reverse order of removal.

The tightening torque of the left front cover mounting bolt is: (10~15) N·m

NOTE: When installing the sealing paper pad, you need to use a new sealing paper pad.

REMOVAL OR INSTALLATION OF MAGNETO STATOR

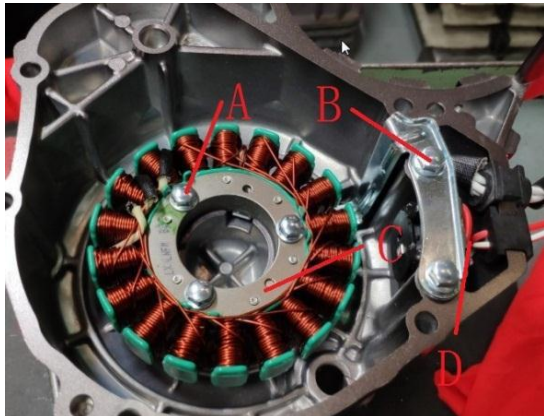

The removal steps of the magneto stator are as follows:

1. Remove the mounting bolt B of the stator crimping plate.
2. Remove the stator crimping plate.
3. Remove the trigger component D.
4. Remove the stator mounting bolt A.
5. Remove the magneto stator C.

Installation is carried out in the reverse order of removal.

The tightening torque of A and B is: (5~7) N·m

REMOVAL OR INSTALLATION OF THE MAGNETO ROTOR



The removal steps of the magneto rotor are as follows:

1. Remove the rotor mounting bolts.
2. Remove the rotor fixing gasket.
3. Remove the rotor part of the magneto.

Installation is carried out in the reverse order of removal.

NOTE: Clean the conical surface of the crankshaft and the oil in the cone hole of the rotor before installing the rotor;

When installing the rotor fastening bolts, apply a proper amount of thread fastening glue on the threads;

The bolt tightening torque is: 65~70N·m.

REMOVAL OR INSTALLATION OF ELECTRIC START GEAR

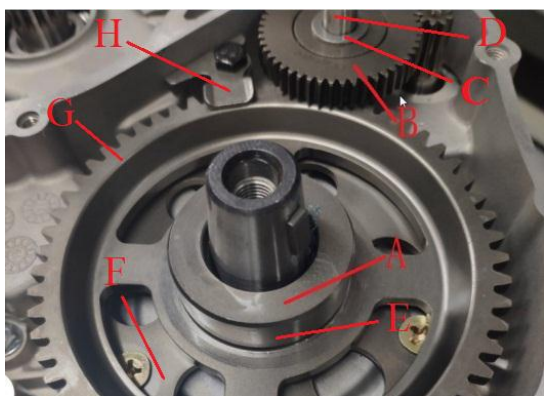

The removal steps of the electric start gear are as follows:

1. Remove the pressure plate H of the electric start driven wheel.
2. Remove the double gear B and the flat washer C. (one on top and one on top)
3. Remove the double gear shaft D.
4. Remove bearing retaining ring A.
5. Remove the electric start driven gear G.
6. Remove bearing E.
7. Remove the crankshaft left oil seal baffle F.

8. Check whether the double gear and the driven gear are worn or damaged, if any, replace it.

Installation is carried out in the reverse order of removal.

Torque of tightening bolts of electric start driven wheel pressing plate: 10~14N·m

ENGINE CRANKSHAFT AND TRANSMISSION MECHANISM

PREPARATIONS BEFORE REMOVING THE CRANKCASE

When removing the crankshaft and transmission mechanism, remove the crankcase. The removal of other parts of the engine should be carried out before removing the crankcase. The specific steps are as follows:

1. Remove the engine and place it on a clean workbench.
2. Release the lubricating oil.
3. Remove the right crankcase cover.
4. Remove the clutch parts.
5. Remove the left front cover.
6. Remove the magneto parts.
7. Remove the starter motor.
8. Remove the shift arm parts.
9. Remove the stop plate combination and the five-star dial plate.
10. Remove the cylinder head parts.
11. Remove the cylinder block parts.
12. Remove the piston parts.

SPECIFICATIONS OF CRANKSHAFT AND TRANSMISSION MECHANISM

ITEM	STANDARD (mm)	REPAIR LIMIT VALUE (mm)
Radial clearance of linkage big end	0.027~0.039	0.05
Total clearance between the end face of the linkage and the end face of the crank	0.25~0.65	/
Fork plate thickness	4.93~5.0	4.83
Fork pin diameter	Φ5.93~Φ6.0	/
Gear fork groove width	5.1~5.2	/
Width of shift fork groove	6.05~6.15	6.2

REMOVAL OF CRANKCASE



The removal steps of the crankcase are as follows:

1. Loosen the connecting bolts of the crankcase.
2. Remove the right crankcase.
3. Remove the positioning pin of the box.

Remove the sealant on the end face, do not damage the end face of the box

NOTE: Separate the crankcase by tapping the left and right crankcases with a soft hammer. Do not use a screwdriver to pry the crankcase or tap the crankshaft.

REMOVAL OF THE TRANSMISSION MECHANISM

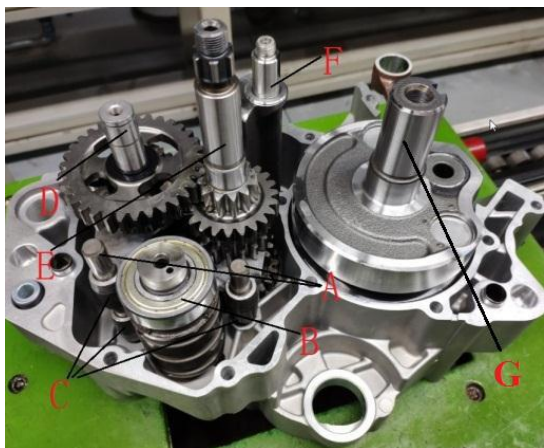

The removal steps of the transmission mechanism are as follows:

1. Remove the fork shaft A.
2. Remove shift fork C.
3. Remove variable speed drum B.
4. Remove the main shaft E and the secondary shaft D.
5. Remove balance shaft F.
6. Remove crankshaft G.

CRANKSHAFT INSPECTION

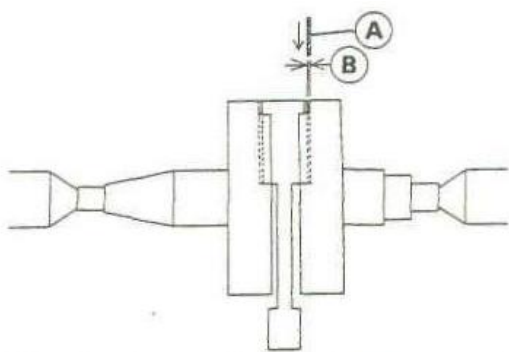

Use thickness gauge A to measure the total clearance B between the end face of the crankshaft connecting rod and the end face of the crank.

Standard value: 0.25~0.65

Rotate the crankshaft by hand and check its radial run-out with a dial indicator

Standard value: 0.027~0.039

Repair limit value: 0.05

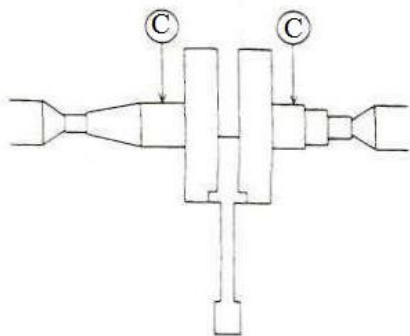

Check the crankshaft bearing for wear or damage, if any, replace it.

TRANSMISSION MECHANISM INSPECTION

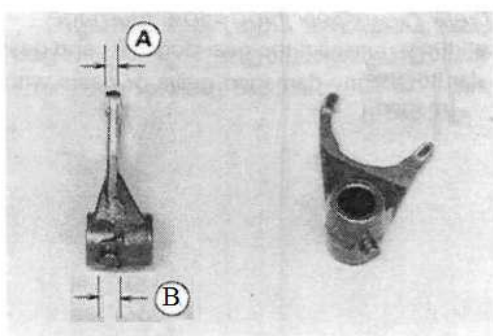

Check the thickness of the shift fork plate A.
Standard value: 4.93~5.0
Repair limit value: 4.83

Check the fork pin diameter B
Standard value: 5.93~6.0

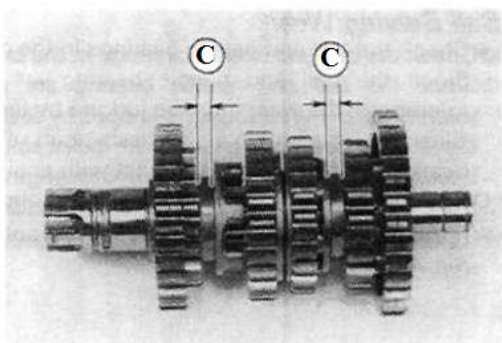

Check whether the rotation and axial sliding of the gears of the main and counter shafts are flexible.

Check whether the gears of the main and counter shafts are worn or damaged.

Check the width of the shift fork groove C.

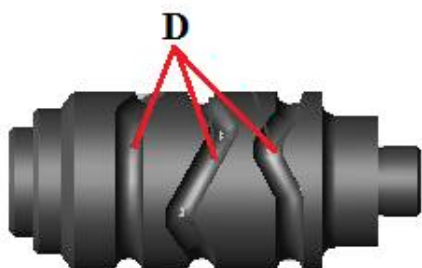

Standard value:
5.1~5.2

INSTALLATION OF TRANSMISSION MECHANISM



The installation steps of the transmission mechanism are as follows:

1. Heat the crankshaft bearing hole of the left crankcase to 130~150°C.
2. Gently press the crankshaft into the crankcase.
3. Turn the crankshaft to see if it turns flexibly.
4. Assemble the main and auxiliary shafts into the crankcase at the same time.

5. Fork the shift plate into the main and auxiliary shafts.
6. Put the fork pin into the groove of the shift drum.

NOTE: Do not install the wrong mark on the fork.

7. Align the fork shaft holes of the fork.
8. Insert the fork shaft.
9. Rotate the main and auxiliary shafts to see if they can rotate flexibly. If not, follow the above steps to reassemble the components of the transmission mechanism.

10. Lubricate the gears and rotating parts.
11. Put sealant on the joint surface of the box body.
12. Install the positioning pin A into the corresponding position.
13. Install the bushing B into the corresponding position
14. Close the left crankcase to the right crankcase.
15. Tighten the crankcase mounting bolts.
16. The bolt installation torque is 8~12N·m.

INSTALLATION OF REMAINING PARTS

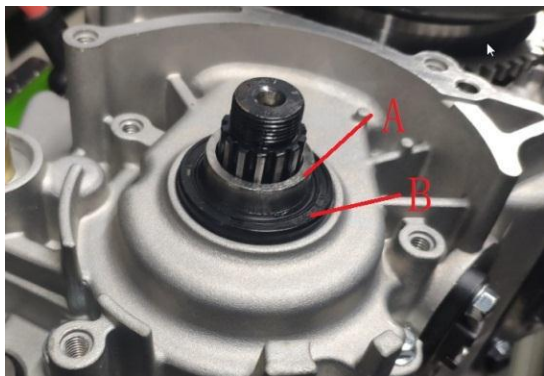

The installation steps are as follows:

1. Install O-ring B and counter shaft sleeve A on the counter shaft.
2. Apply a proper amount of thread fastening glue to the thread of the counter shaft.
3. Install the countershaft drive sprocket (Xiaofei), sprocket lock washer, and drive sprocket lock nut in sequence. The tightening torque of the nut is 40-50N·m, and pry up at the flat side of the lock nut.
4. The lock washer locks the nut.
5. Install the piston parts.
6. Install the cylinder block parts.
7. Install the cylinder head parts.
8. Install the stop plate combination and the five-star dial plate.
9. Install the shift arm parts.
10. Install the driving gear and balance shaft gear.
11. Install electric starting gear and starting motor.
12. Install the magneto parts.
13. Install the left front cover.
14. Install the clutch parts.
15. Install the right crankcase cover.
16. Inject lubricating oil.

ZHEJIANG KAYO MOTOR CO., LTD.

ENGINE TIGHTENING TORQUE TABLE

The engine tightening torque table is as follows:

No	Applicable parts	TORQUE VALUE
1	Cylinder head nut M8	28-32N.m
2	Cylinder head boltM6	10-15N.m
3	Timing sprocket	10-15N.m
4	Clutch tightening nut	40-50N.m
5	Magneto rotor bolt	65-71N.m
6	Valve cover	12-18N.m
7	box bolt	10-15N.m

TROUBLESHOOTING

If the engine wants to be operated normally, it should meet the following four requirements:

1. Good fuel: There is a certain ratio of combustible mixture in the cylinder.
2. Good spark: The spark plug can emit a strong spark at the specified time.
3. Enough compression: There is enough compression pressure in the cylinder.
4. Valve timing: correct valve opening time.

After the engine malfunctions, you can focus on the above four aspects to start, check, analyze the cause of the malfunction, and eliminate it

FAULTS	Inspection Method	Results	Possible Cause	
The engine cannot be started or difficult to start	Check whether the fuel flows into the carburetor	Fuel does not flow into the carburetor	No gasoline in the fuel tank	
			Blocked tubing from the fuel tank to the carburetor	
		Fuel flows into the carburetor	The float in the carburetor is stuck	
			The vent on the fuel tank cap is blocked	
	Remove the spark plug to test the spark	Weak sparks or no sparks at all	Spark plug failure	
			The spark plug is not clean	
		Good sparks	Electronic ignition is malfunctioning	
			The magneto is faulty	
				Bad wiring, broken
				High-voltage cable is open or short-circuited
			Ignition coil is open	

ZHEJIANG KAYO MOTOR CO., LTD.

			or short-circuited
			The ignition switch is faulty
	Test cylinder pressure	Low Pressure	The starting mechanism is slipping, and the engine cannot be turned
		Normal pressure	Valve clearance is too small
			Valve opening blocked
			Cylinder or piston ring wear
			Cylinder head gasket is broken
			Improper valve timing
	Re-start the engine	The engine ignites but does not start	The choke door is opened too much
			Improper adjustment of the carburetor fine-tuning screw
	Remove the spark plug	Wet spark plug	Air intake pipe leaks
			Incorrect ignition timing
	Remove the spark plug	Spark plug dry	The carburetor oil level is too high
			The carburetor choke is closed too tightly
The engine performs poorly at low or idling speeds	Check valve timing and valve clearance	Incorrect	Excessive throttle
		Correct	Improper valve clearance adjustment or poor quality of rocker arm adjustment screws
	Check the adjustment	Incorrect	Improper adjustment of gas timing
			Improper adjustment

ZHEJIANG KAYO MOTOR CO., LTD.

	of the fine adjustment screw of the carburetor plunger	Correct	/
	Check whether the carburetor gasket is leaking	Air leak	Deterioration of carburetor seal ring
		Airtight	Loose carburetor Damaged carburetor gasket
	Remove the spark plug and perform a spark test	Weak sparks or intermittent sparks	The spark plug is faulty or carbon deposits
			The electronic igniter is malfunctioning
			The magneto is faulty
		Good spark plug	The spark plug cap is faulty The power circuit is faulty
The engine performs poorly at high speeds	Check the ignition timing and valve clearance	Incorrect	The ignition controller is faulty
			Improper valve clearance adjustment
			The magneto is faulty
		Valve clearance and ignition timing are correct	/
	Disassemble the connection of the fuel pipe of the carburetor and check if the fuel pipe is blocked	Insufficient fuel flow	The fuel tank has run out Blocked fuel pipe
		The fuel pipe has sufficient flow	Blocked fuel tank cap vent
	Check if the filter and carburetor nozzle are blocked	Blockage	Blocked carburetor measuring hole
		Unblocked	Float stuck
			Filter blocked
	Check gas timing	Incorrect	Adjust gas timing
Correct		/	
Check valve spring pressure	Insufficient Pressure	Worn or broken valve spring	

ZHEJIANG KAYO MOTOR CO., LTD.

The engine has abnormal noise	Check whether there is abnormal noise in the valve	Abnormal noise in the valve	Valve clearance is too large
			Valve wear
	Check whether there is abnormal noise in the cylinder	Cylinder has abnormal noise	Piston and cylinder wear
			The small end holes of the piston pin and connecting rod are worn
			Crank pin and connecting rod large end wear
	Check whether the timing chain produces abnormal noise	Abnormal noise in the chain	Camshaft wear
			Timing driven sprocket wear
			Timing chain stretched
			The timing chain automatic tensioner fails, or the guide wheel is worn
	Check whether the driving gear and the driven gear produce abnormal noise	Abnormal noise in the driving and driven gears	Gear machining accuracy is not enough
			The gear teeth are worn
			The matching clearance between the driving and driven gears is too small or too large

SELECTION AND RATIO OF ENGINE OIL

In the process of engine work, the oil has the functions of lubrication, cooling, cleaning, rust prevention, sealing and noise reduction. Compared with the four-stroke engine oil that only lubricates and does not participate in the combustion, the two-stroke engine oil needs to be mixed with gasoline and then be used as fuel. So, the fuel of two-stroke engine is also required to play a lubricating role while participating in combustion.

The difference between two-stroke engine oil and four-stroke engine oil is as follows:

Item	Two-stroke engine oil	Four-stroke engine oil
Flash point [1]	low, flammable	high, flash point >200°C
Thinner	Yes	No

ZHEJIANG KAYO MOTOR CO., LTD.

Viscosity	Low	high, the viscosity is 40, 50 or 60
Compounding agent	without ZDDP [2]	with ZDDP
Viscosity index improver	Low molecular weight PIB [3]	High molecular weight PIB
Ash [4]	Low	High

[1] Flash point: Flash is kind of fleeting flashing phenomenon. It is occurred when flammable gas, which is mixed gas of vapor produced on the surface and air, encounters a fire. The flash point is the lowest temperature of flash.

[2] ZDDP: Abbreviation for Zinc Dialkyl Dithiophosphates, which is an antioxidant and anticorrosive agent in lubricating oil additives, that is, a multifunctional agent. Adding this series of additives to oil can control the oxidation of oil, and has anti-oxidation, anti-wear and anti-corrosion effects.

[3] PIB: Abbreviation for Polyisobutylene, used as a thickener, and used with other materials to improve adhesion, flexibility, aging resistance, air tightness and electrical insulation.

[4] Ash content: Ash content refers to the inorganic matter obtained by calcining the remaining residue after the sample is sintered under specified conditions, expressed in mass percentage.

When choosing a two-stroke engine oil, the following conditions should be met:

- ①Has good lubricity;
- ②Excellent cleanliness;
- ③It can prevent premature ignition;
- ④It can prevent the spark plug from scaling and forming deposits;
- ⑤It can prevent the exhaust pipe from being blocked;
- ⑥Meet low smoke emission requirements;
- ⑦It has miscibility with fuel.

Regarding the choice of engine oil, KAYO recommends you choose TORCO GP-7 fully synthetic engine oil (Exceeds JASO-FC, ISO-L-EGD, API-TC) as the one for KT250 models.

A bottle of that will be sent with the corresponding model. (Actually, This implementation will be operated according to the relevant regulations of the country where the customer.)

The recommended fuel mixture ratio (gasoline: engine oil) for each model is

	KT250
Run-in period	30: 1
After the run-in period	30: 1



NOTE: The oils shown above are only used for mixing with gasoline, not for gearbox lubrication. KAYO chooses SJ 5W-40 four-stroke engine oil as the gear oil for the engines of various models. The gear oil should be replaced every 20 hours.

MOTORCYCLE CLEANING

The cleaning of the vehicle is also an important part of the daily use and maintenance of the motorcycle. Frequent cleaning of your motorcycle can keep your car in a good state of motion and prolong its service life. You can clean your motorcycle through the following steps:

1. Cover the exhaust system to prevent water from entering;
2. Seal the electric door lock and all connectors with tape;
3. Use a low-pressure water spray device to remove the mud and dirt on the surface;
4. Use a special motorcycle cleaner to clean particularly dirty places;
5. Flush with low-pressure water flow;
6. Let the motorcycle air dry naturally;
7. Drive the motorcycle for a short period of time until the engine reaches the working temperature;
8. Lubricate the chain and all other parts that need to be lubricated.

WARNING: Never use high-pressure water to clean the vehicle. Avoid direct contact with coils, pipe plugs, carburetor or any electrical components.

STORAGE

PREPARING FOR LONG STORAGE

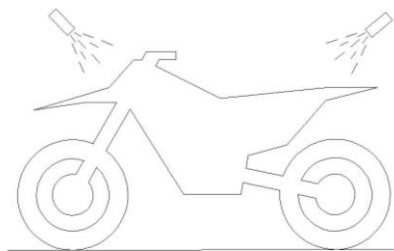

If you want to garage the motorcycle for a longer period, take the following steps.

1. Block the exhaust port of the muffler tube;
2. Remove the battery
3. Clean the motorcycle
4. Wait for the motorcycle to dry naturally;
5. Empty the fuel tank (if not used for a long time, the gasoline will deteriorate);
6. Lubricate the chain;
7. Apply oil to all unpainted metal surfaces to avoid rust;
8. When storing the motorcycle, keep the motorcycle wheels suspended. If this condition cannot be achieved, you can use cardboard to pad under the motorcycle tires;
9. Cover the motorcycle to prevent dust and dirt.
10. Move the motorcycle into a dry room and place it.

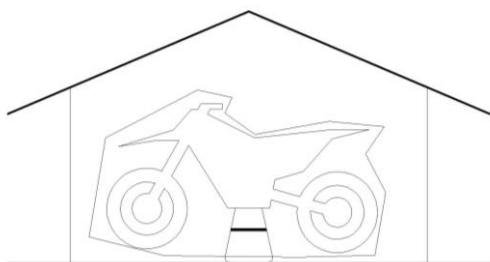

NOTE: When applying anti-rust oil, please do not splash the oil on the brake and rubber parts, otherwise the rubber may be aged.

PREPARING FOR USE AFTER LONG STORAGE

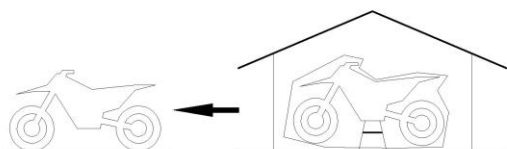

After the motorcycle has been stored for a long time, please follow the steps below when it is put into use:

1. Take out the blockage in the exhaust port of the muffler tube;
2. Tighten the spark plug;
3. Fill the fuel tank with fuel;
4. Install the battery;
5. Check the items that need to be checked before daily driving;
6. Routine lubrication for motorcycles.

MAINTENANCE POINTS

In the following content, we will enumerate the problems that occurred during your use, find out the possible causes and give general solutions.

Problems	Reason	Solution
The crank of the engine cannot be turned	Crank stuck	Contact KAYO Service Center
	Cylinder/piston/ connecting rod stuck	Contact KAYO Service Center
	Gearbox stuck	Contact KAYO Service Center
The engine does not start when the electric starter is pressed	The starting relay fuse is blown	Remove the seat cushion and check the fuse, if the fuse is blown, replace the fuse
	Low battery Volume	Remove the seat cushion and

ZHEJIANG KAYO MOTOR CO., LTD.

		check the battery
Engine cannot be started	The motorcycle has been stored for a long time and the fuel has deteriorated	Drain the old fuel and add new fuel
	Dirt or wet spark plug	Clean or dry the spark plug, if necessary, replace the spark plug
	Engine water intake	<p>First, drain the mixed fuel out the engine and remove the crankcase of the engine, clean it with a strong cleaning agent, then remove the spark plug, blow it dry with a fan (the machine that inflates the tires), and then wipe the air filter element. Finally, remove the exhaust pipe of the engine and blow it dry with a fan. After everything is done, the car owner should add new mixed fuel to the engine before the car can drive. Because the moisture in the crankcase is difficult to completely evaporate, the new fuel still contains a small amount of moisture. Therefore, after the engine has flooded and the car has run for 100 kilometers, the fuel should be changed again, and then again within 500 kilometers. After three times, the water in the carburetor is almost gone.</p> <p>If water enters the cylinder, depress the start lever several times after the flame is turned off. Step on it for a few times, the water in the cylinder will be drained from the exhaust pipe, and then use a fan to blow on the mouth of the oil dipstick for a few minutes.</p> <p>Warning: In safety sake, the spark plug should be wrapped with dry cloth to avoid spark jumping.</p>
	Incorrect mixing of air and fuel	Clean the fuel tank vent pipe, adjust the air filter duct

ZHEJIANG KAYO MOTOR CO., LTD.

	Open exhaust valve	Check and correct the exhaust valve
The engine can be started, but it will stop immediately	Incorrect air supply	Close the choke valve, clean the fuel tank vent pipe, and adjust the air filter duct
	Lack of fuel	Add fuel
Engine overheated	Lack of antifreeze	Replenish antifreeze and check for leaks in the cooling system
	Clogged water tank fins	Use low-pressure water to clean the fins of the water tank and replace them if necessary
Unbalanced engine operation	The spark plug is dirty, damaged or adjusted incorrectly	Remove the spark plug for cleaning, adjustment, and replacement if necessary
	There is a problem with the spark plug cap	Check the condition of the spark plug cap, check whether the spark plug cap is in good contact with the cable itself, check the cable, and replace the damaged parts
	Ignition rotor is damaged	Replace the rotor
	Water mixed in the fuel	Empty the fuel, then inject new fuel
Insufficient engine power or poor acceleration	Problems with fuel supply	Clean fuel system and check
	Dirt in the air filter	Clean the air filter and replace if necessary
	Damaged or leaking exhaust system	Check whether the exhaust system is damaged, and replace related accessories if necessary
	Dirt in the carburetor nozzle	Remove the carburetor and clean the nozzle
	Damaged or worn crankshaft bearings	Contact KAYO Service Center
Engine sound is abnormal	Problem with ignition	Contact KAYO Service Center
	overheat	See "Engine Overheating" section
Exhaust pipe backfire phenomenon	Carbon deposits in the combustion chamber	Contact KAYO Service Center
	Poor gasoline	Change fuel
	The spark plug is in poor condition or the specification is wrong	Replace with a new spark plug with the correct specification
	Exhaust system gasket aging	Check whether the exhaust system is damaged, check whether the gasket is in good condition, if the

ZHEJIANG KAYO MOTOR CO., LTD.

		gasket is aging, replace the gasket
White smoke from exhaust pipe	The fuel contains water	Change fuel
Black smoke from exhaust pipe	Air filter is clogged	Remove and clean the air filter
	The combustible mixture is too rich	Adjust the carburetor valve
Gearbox gear does not mesh	Clutch abnormality	Contact KAYO Service Center
	The fork is bent or stuck	Check and adjust the fork
	Damaged gear lever	Replace the gear lever
	Damaged gear shift drum	Replace the shift drum
	Damaged ratchet device	Replace the ratchet device
	Loose or broken spring at the selector position	Replace the selector position spring
Gear bounce	Fork wear	Replace the fork
	Tooth wear	Check gears and replace if necessary
	Gear damage	Change gear
	Damaged displacement drum groove	Replace the shift drum
	Worn fork shaft	Check the fork shaft and replace if necessary
	The selector position spring is damaged	Replace the selector position spring
Clutch slip	Clutch disc wear	Replace the clutch disc
	The clutch pressure plate spring is too soft or damaged	Replace the clutch spring
	Clutch handle free stroke is too small	Adjust the free stroke of the clutch
The motorcycle is difficult to steer	The cable makes it difficult to turn the handlebars	Move the cable to reduce its interference
	The steering shaft nut is too tight	Adjust the steering shaft nut
	Worn or damaged steering bearings	Check the steering bearing and replace if necessary
	Bent steering shaft	Contact KAYO Service Center
Damping is too hard	Fork oil level is too high	Lower the front fork oil level to a suitable position
	Fork oil viscosity is too high	Replace the fork oil with the right viscosity
	Fork bent	Contact KAYO Service Center
	Tire pressure is too high	Check tire pressure and adjust to proper pressure
	Damping adjustment error	Re-adjust damping
Damping is too soft	Insufficient front fork oil level	Add the right amount of fork oil

ZHEJIANG KAYO MOTOR CO., LTD.

		Note: It is required to add the same kind of oil
	Fork oil viscosity is too low	Change to fork oil with suitable viscosity
	Tire pressure is too low	Check whether the tires are leaking, if the tires are complete, pump them to the proper pressure
	Damping adjustment error	Re-adjust damping
There is abnormal noise when the motorcycle is driving	Improper chain adjustment	Re-adjust the chain tension
	Chain wear	Replace the chain and front and rear sprockets
	Wear of rear sprocket teeth	Replace the sprocket
	Insufficient chain lubrication	Follow the manual to lubricate the chain
	Rear wheel off center	Check the spokes and adjust the spoke tension centrally if necessary
	The fork spring is soft or broken	Replace the front fork spring
	Disc brake disc wear	Check the disc brake disc, if its thickness is less than the limit thickness, replace it
	Damaged cylinder head	Contact KAYO Service Center
	Brackets, nuts, and bolts are not tightly fastened	Check and adjust the torque of the corresponding fasteners
	The gasket is installed incorrectly, is worn, or is too smooth	Readjust the gasket and replace if necessary
Motorcycle front wheel shimmy	Tire wear	Change tires
	Rim offset	Contact KAYO Service Center
	Whether the front wheel bearing is worn	Check the bearing and replace if necessary
	The vehicle is not aligned	Check the spokes and adjust the spoke tension if necessary
	Steering shaft tolerance is too large	Check the steering shaft pressure bearing clearance
	The steering shaft nut is loose, and the handlebar is not fixed	Check and re-tighten
The motorcycle skews to one side	Bent chassis	Contact KAYO Service Center
	Improper steering adjustment	Check and readjust
	Bent steering shaft	Contact KAYO Service Center
	There is a problem with the fork	Contact KAYO Service Center
	Vehicle is not aligned	Re-adjust the spoke tension and contact KAYO Service Center if

ZHEJIANG KAYO MOTOR CO., LTD.

		necessary
Brake failure	Disc brake disc wear	Replace the disc brake
	Insufficient brake fluid	Replenish brake fluid
	Deteriorating brake fluid	Replace brake fluid
	Piston damaged	Contact KAYO Service Center
	Brake pad wear	Check the brake pads, if the thickness is less than the minimum friction thickness, replace the brake pads

TIGHTENING TORQUE TABLE FOR THE WHOLE VEHICLE

NOTE: Before installing the thread, apply anti-rust grease on the thread and the joint surface

No	ITEM	DESCRIPTION	QUANTITY	TORQUE (NM)
1	Front brake caliper mounting bolt	M8×40 full thread	2	20~32
2	Front brake guard mounting screw	M6×16	2	7~11
3	Steering column screw	Aluminum silver	1	/
4	Upper pressure block mounting screws	M8×30	4	20~32
5	Front disc brake rotor mounting bolt	M6×16	6	7~11
6	Front axle mounting nut	M16×1.5×H14	1	175~218
7	Pedal seat mounting bolt	M8×20 full thread	2	20~32
8	Shift lever mounting bolt	M6×25	1	7~11
9	Engine hanger bolt	M8×60	3	20~32
10	Engine mounting nut	M10×1.25	2	40~70
11	Water tank mounting screws	M6×25	4	7~11
12	Exhaust pipe mounting nut	M8	2	20~32
13	Guide chain sleeve mounting screws	M6×12	3	7~11
14	Flat fork shaft mounting nut	M16×1.5×H14.8	1	175~218
15	Tripod mounting nut	M12×1.25	3	68~85
16	Chain bolt	M10×40×1.25 S14	2	36~55
17	Adjusting chain nut	M10×1.25	2	40~70
18	Rear reduction and frame connecting bolt	M10×50×1.25	1	40~70
19	Oval head bolts	M10×42×1.25+Φ10×2 8	1	40~70
20	Rear brake disc mounting bolt	M6×16	4	7~11

ZHEJIANG KAYO MOTOR CO., LTD.

21	Rear sprocket mounting screws	M8×31 10.9 level	6	27~35
22	Rear axle nut	M22×1.5	1	452~550
23	Rear brake disc guard mounting bolt	M6×12	4	7~11
24	Brake pedal head mounting screw	M5×10 full thread	2	4~7
25	Brake limit bolt	M8×20 full thread	1	20~32
26	Rear brake pump mounting bolt	M6×16 full thread	2	7~11
27	Brake pedal bolt	M6×25 full thread	1	7~11
28	High voltage package mounting bolt	M6×20	2	7~11
29	Plastic mounting bolts	M6×16 full thread	10	7~11
30	Igniter mounting bolt	M6×16 full thread	2	7~11
31	Voltage stabilizer mounting bolt	M6×25 full thread	2	7~11
32	Electric door lock bracket bolt	M6×12	2	7~11
33	Fuel tank switch mounting screws	M5×12 full thread	2	4~7
34	Front fender bolt	M6×12	4	7~11
35	Screws connecting the left and right guard plates to the fuel tank	M5×10 full thread	6	4~7
36	Phillips pan head tapping screws	ST 4.2×12	10	/
37	Phillips flat head machine screw	M6×10	4	/
38	Spark plug	/	1	25~30