

# KAYO MOTO

TT 140

## SERVICE MANUAL



[www.kayomoto.com](http://www.kayomoto.com)

This service manual is edited by KAYO.  
Please do not modify the content without authorization.  
Manufacturer has the right to improve and update the model's structure and spare parts without notice.  
The model in the image may be different from the real model.

## **PREFACE**

Thank you for choosing the 21 TD140 of KAYO MOTO as your choice for off-road recreation. I believe you will not be disappointed with this choice.

This manual is designed to help you better use our products. This manual describes in detail the maintenance and adjustment procedures, disassembly and assembly essentials, inspection and maintenance points, troubleshooting methods and maintenance technical data of TT140, with detailed graphic data to guide the operation. Please read this manual carefully and carry out maintenance according to the standard operation techniques, which can effectively prolong the service life of each component, improve the engine performance and the reliability of

the vehicle.

For the sake of technological development, KAYO reserves the right to modify the construction, equipment and parts of the motorcycle without prior notice. Due to the different regulations and requirements in different markets, we have made appropriate adjustments to the models, so the images in the manual may be different from the standard motorcycle. In addition, if you have any questions, please go to our official website [www.kayomoto.com](http://www.kayomoto.com) and contact our service staff. We must accept with humility.

The contents of this manual are subject to change without prior notice due to vehicle improvement. The actual state of the vehicle shall prevail during maintenance.

ZHEJIANG KAYO MOTOR CO., LTD.  
ENGINEERING OFFICE  
AUGUST. 2021

# Content

<b>Meaning of Symbols and Technical Terms</b>	<b>6</b>
<b>Suggestions for Daily Use</b>	<b>7</b>
<b>Parts and Position</b>	<b>8</b>
21 TT 140 Parts and Position	8
<b>Steel chassis</b>	<b>9</b>
<b>VIN and Engine Number</b>	<b>10</b>
VIN Number	10
Engine Number	10
<b>Specification</b>	<b>11</b>
<b>Manipulation</b>	<b>12</b>
Front disc brake	12
Throttle	12
Ignition	13
Stall	13
Fuel tank switch	13
Gear Shifting	14
Rear disc brake	14
Parking stand	15
<b>Notes before use</b>	<b>16</b>
Suggestions for first-time users	16
Running-in process	16
<b>Riding guide</b>	<b>17</b>
Checking items before riding	17
Notes when ignition	17
Notes when starting	17
Notes when cornering	18
Notes when acceleration	18
Notes when gear shifting	18
Notes when braking	18
Notes when parking	18
<b>Maintenance Periodic Table</b>	<b>19</b>
<b>Suspension system setup</b>	<b>20</b>
Check the compression and rebound of the motorcycle when riding	20
Measure distance from center of rear wheel to rear fender in suspension	20
Measure distance from center of rear wheel to rear fender under no load	20
Measure distance from center of rear wheel to rear fender in riding condition	21
Adjust the spring preload of the rear shock	22
Check the setup of the front shock	22
Adjust handlebar	22
<b>Maintenance</b>	<b>23</b>
Placement of motorcycle	23
Disassembly and assembly of front shock protector	23
Disassembly and assembly of front disc brake	23
Disassembly and assembly of front shock	24
Disassembly and assembly of clamp	24
Check the head steering	24
Lubrication and installation of steering head bearing	25
Disassembly and assembly of front fender	25
Disassembly and assembly of rear shock	26
Disassembly and assembly of seat	26
Disassembly and assembly of air filter	26
Cleaning and maintenance of air filters	26
Disassembly and assembly of exhaust pipe	27
Disassembly and assembly of muffler	27
Disassembly and assembly of fuel tank	28
Check the chain and clean	28



Disassembly and assembly of the chain	28
Check and adjust the chain tension	28
Inspect rear sprocket, engine sprocket and chain guide structure	29
Inspection of the frame	30
Inspection of the swing arm	30
Inspection of the throttle cable	30
Inspection of the handle bar	30
<b>Check and maintain the brake system</b>	<b>31</b>
Check the free stroke of the front brake handle	31
Inspection of the disc brake	31
Check the fluid level of front brake disc	32
Refill the front brake disc fluid oil	32
Inspection of the disc brake	32
Check the free movement of the foot brake	33
Check the rear disc brake fluid level	33
Refill rear disc brake fluid	34
<b>Tire inspection and maintenance</b>	<b>35</b>
Removal and installation of front wheel	35
Removal and installation of rear wheel	35
Check the outside surface of the tire	35
Check tire pressure	36
Check the wheel spokes	36
<b>Engine installation</b>	<b>37</b>
<b>Engine maintenance and adjustment</b>	<b>37</b>
Inspection of bolts and nuts of cylinder and cylinder body	37
Check valve clearance	37
Inspection of compression pressure	38
Adjustment of clutch control system	38
<b>Adjustment around the engine</b>	<b>39</b>
Idle speed adjustment of carburetor	39
Clean the carburetor	39
Check shift lever position	40
Adjust the position of the shift lever	40
Check and replace spark plug	41
<b>Lubrication system of engines</b>	<b>42</b>
Selection of lubrication oil	42
Lubricating oil inspection	42
Lubricating oil replacement	42
<b>Engine repair</b>	<b>43</b>
Cylinder and valves	43
Main parameters and maintenance standards of cylinder parts	44
Fault symptom and cause analysis	44
Removal of left cover of cylinder head	45
Timing check	45
Removal of valve cover	46
Check valve clearance	46
Removal of cylinder head	46
Disassembly of cylinder head	47
Inspection of valves and valve springs	48
Inspection of rocker arm and rocker arm shaft	48
Inspection of camshaft components	49
Inspection of cylinder head	49
Check and grind valve seats	49
Inspection of valve guide	50
Replacement of valve guide	50
Measure width of valve seat contact area	50
Assembly of cylinder head	51
Installation of cylinder head	52

Cylinder block and piston	53
Main parameters and maintenance standards of cylinder block and piston	53
Fault symptom and cause analysis	54
Inspection of cylinder block	55
Removal of piston and piston ring	56
Inspection of piston and piston ring	56
Installation of piston ring	57
Installation of piston	57
Installation of cylinder block	58
Clutch, driving gear, driven gear, oil pump, shifting mechanism	58
Main parameters and maintenance standards	59
Fault symptom and cause analysis	59
Removal of right trim cover	60
Adjustment of clutch stroke	60
Removal of right crankcase cover	60
Clutch disassembly	61
Disassembly of driving and driven gears	61
Removal of engine oil pump	61
Disassemble shift mechanism	62
Inspection of right crankcase cover	62
Inspection of driving and driven tooth	63
Check the oil pump	63
Check shift mechanism	64
Assembly of shift mechanism	64
Assembly of oil pump	64
Assembly of driving and driven teeth	65
Clutch assembly	65
Installation of clutch	66
Assembly of right crankcase cover	66
Assembly of right crankcase cover	67
Right trim cover for installation	67
Magneto, timing chain	67
Removal of left rear cover	68
Removal of left front cover	68
Removal of magneto stator	68
Removal of magneto rotor	69
Removal of starting motor and starting sprocket	69
Removal of transition plate	70
Removal of timing chain	70
Removal of tensioning arm, tensioning rod and tensioning roller	70
Inspection of left front cover and left back cover	70
Transition plate, starting motor, starting sprocket inspection	71
Magneto stator, rotor inspection	71
Installation of tensioning arm, tensioning rod and tensioning roller	72
Transition plate installation	72
Installation of starting motor and starting sprocket	73
Installation of magneto stator	73
Installation of magneto rotor	74
Installation of left cover	74
Crankcase, crankshaft, main and auxiliary shafts and speed drum	74
Main parameters and maintenance standards	75
Fault symptom and cause analysis	75
Decomposition of crankcase	75
Disassembly of crankshaft, main and auxiliary shaft	76
Decomposition of variable speed drum	76
Inspection of crankshaft	76
Left and right crankshaft box bearing inspection	77
Check shift fork, fork shaft and shift drum	77

Check the combination of main and auxiliary shafts	78
Inspection of starting shaft	78
Assembly of variable speed drum	78
Installation of variable speed drum, main and auxiliary shaft, crankshaft and starting shaft	79
Installation of crankcase	79
<b>Engine troubleshooting</b>	<b>81</b>
<b>Motorcycle cleaning</b>	<b>84</b>
<b>Storage of motorcycles</b>	<b>85</b>
The preparation of the motorcycle before long unused	85
<b>The main points of maintenance</b>	<b>86</b>
<b>Vehicle tightening torque meter</b>	<b>91</b>

## Meaning of Symbols and Technical Terms

The symbol "\*" indicates that the operation requires professional knowledge and technical understanding of the operator. If you do not have confidence to complete this operation, you can go to a professional maintenance shop or KAYO after-sale service, to operate by professionals.

The symbol "→" indicates that the specific information is on the following page number.

### **DANGER/WARNING/CAUTION**

In this manual, the words "DANGER/WARNING/CAUTION" will appear. Please read their following words carefully to protect yourself and your vehicle. The meanings of "DANGER", "WARNING" and "CAUTION" are as follows:

**DANGER:** Be alert to a high level of danger

**WARNING:** Be vigilant to moderate risk

**CAUTION:** Be alert to minor danger

Please note that in this manual, we only enumerate the main safety issues related to vehicle maintenance and repair, so the contents of warning symbols cannot cover all the potential dangers during the use and repair of the vehicle.

Therefore, in addition to the related matters that "DANGER", "WARNING" and "CAUTION" indicate, users must also have a basic knowledge of mechanical safety. If you are not sure to complete the entire maintenance and repair operation, please consult a more experienced senior technician before operation.

## **Suggestions for Daily Use**

The vast majority of off-road motorcycle fatalities are caused by head injuries. Without helmets, the chances of serious injury or death from a head-hit will be much higher. Therefore, we strongly recommend that you wear a full set of safety equipment such as helmet, goggles, gloves and boots when driving, which will save your life at the critical moment.

The purpose of this series of models at the beginning of the design is off-road racing, without considering the purpose of carrying passengers, and this bike does not have a rear seat, handles and pedals for carrying people, so please be sure not to use this bike to carry other people except the driver, this behavior can easily lead to safety accidents.

Try to avoid using non-original parts to modify the bike, and do not arbitrarily delete the original parts of the bike, if you need to replace the parts of the bike, please choose the original parts produced by KAYO or parts from authorized manufacturers by KAYO. In addition, KAYO is not responsible for any vehicle problems caused by personal modification and the use of unauthorized parts.

Please check your motorcycle carefully before each use and maintain it according to the maintenance manual after use. After the vehicle falls, please first check whether the main parts are damaged, because driving a motorcycle with a fault is very easy to lead to the occurrence of accidents, endanger riders' own safety.

When in use, the temperature of the engine and exhaust pipe is very high, so it will take some time to cool down after parking. During this period, please do not touch or move the engine and exhaust pipe to avoid burns.

## Parts and Position

### 21 TT 140 Parts and Position



No.	Name	No.	Name
1	Front fender	10	Front fork
2	Headlight	11	Fuel tank
3	Handlebar	12	Carburetor
4	Vent pipe	13	Gear shift lever
5	Fuel tank cap	14	Pedal
6	Fuel tank petcock	15	Side stand
7	Chain slider	16	Chain
8	Front brake disc	17	Chain guide
9	Front brake caliper	18	Rear sprocket

19 20 21 22 23 24



25 26 27 28 29 30 31

No.	Name	No.	Name
19	Rear fender	26	Rear brake caliper
20	Muffler	27	Swing arm
21	Seat	28	Rear brake oil cup
22	Rear shock	29	Brake pedal
23	Upper clamp	30	Steel chassis
24	Lower clamp	31	Muffler pipe
25	Rear brake disc		

VIN and Engine Number

VIN Number

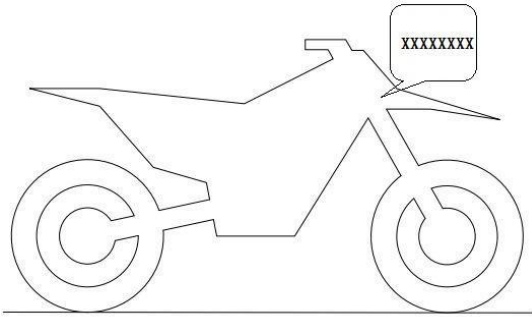

VIN Number of 21 TT 140 is carved on the frame of head pipe.

### Engine Number



Engine Number of 21 TT140 is carved on the engine crankcase body behind gear lever.

### Specification

TT140 size and quality parameters	
Length*Width*Height (mm)	1780×750×1120
Wheelbase (mm)	1220
Weight (kg)	72
Tyre size	Front 70/100-17; Rear90/100-14
Seat height (mm)	855
Ground clearance (mm)	290
Fuel tank capacity (L)	5.5

Engine parameter	
Engine type	Single cylinder, four stroke, air - cooled, manual clutch
Displacement	119.6cc
Max power (kw/r/min)	5.6/8000
Max torque (N•m/r/min)	8.5/5000
Compression ratio	9.3:1
Gear shift type	Constant mesh 4 speed gears
Start method	Kick
Ignition system	CDI
Chain	#428; 15T/41T
Frame/shock/Braking/Wheel parameters	
Frame type	Steel pipe suspension frame,Kayo patent
Front shock absorber	Inverted front shock nonadjustable absorber, L=735mm
Rear shock absorber	Normal rear shock nonadjustable absorber, L=360mm
Rear swing arm	Steel swing arm
Handlebar	Steel handlebar
Front&rear rim	Front: 1.60×17, Rear: 1.85×14; steel rim
Front brake system	Hydraulic brake system, brake discΦ210mm
Rear brake system	Hydraulic brake system, brake discΦ200mm
Other	
Air filter	Sponge filter

## Manipulation

### Front disc brake

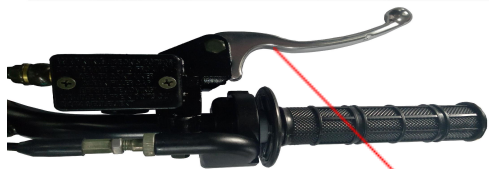

Hand brake handle

The front disc brake is controlled by the hand brake handle, which is located at the right end of the handlebar and operated by the pinching of the handle by the right hand.

The front wheel brake adopts the floating clamp disc brake, which is installed at the lower end of the left front shock and fixed by 2 bolts.





Front brake caliper

## Throttle



Throttle

The throttle is located on the right side of the handlebar and is controlled by right hand rotation. Turn the throttle up when turning the handle counterclockwise, then turn the handle back to the position after releasing the handle.

## Ignition

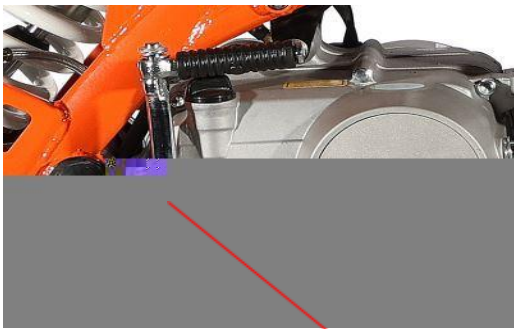

Starting lever

The vehicle starting lever is located on the right side of the engine, and the motorcycle engine can be started by stepping on the starting lever.

**Note:** The brake should be pinched when starting to prevent the engine from starting with the gear.

**Note:** there should be fuel in the fuel tank before starting the engine, and the fuel tank switch should be in the open position.

## Stall



Stall switch

The stall switch of the engine is located on the left side of the handlebar near the handle cover. It is a round red button. Long press it to turn off the engine and make it stall.

## Fuel tank switch

The fuel tank switch is located on the bottom left side of the tank. By rotating the switch, you can control the fuel to flow

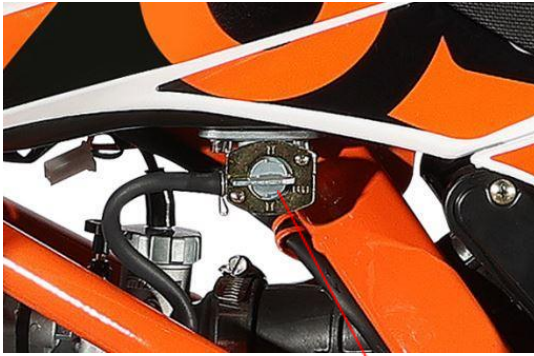

Fuel tank switch

into the carburetor, so as to achieve control effect.

## Gear Shifting

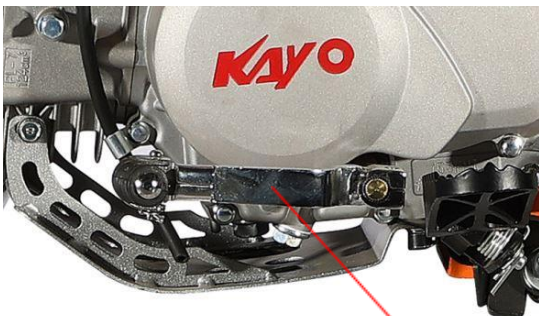

Gearshift lever

The shift lever is located on the left side of the engine, which is operated by stepping on and lifting the shift lever. The 21 TT140 engines are in four-gear gear with constant meshing.

## Rear disc brake



Foot brake pedal

The foot brake pedal is located on the right side of the engine and is operated by stepping.

**Note:** when brake, the foot brake should be the main brake, hand brake as a supplement.

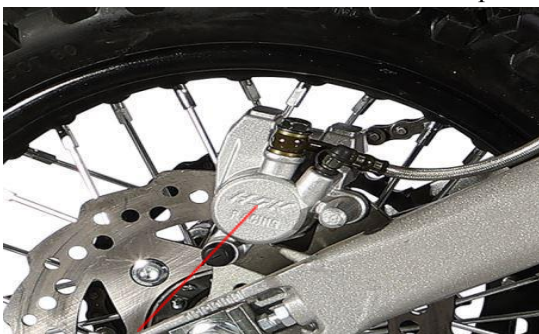

Rear brake caliper

The rear brake adopts a floating clamp disc brake, whose clamp body is located on the right side of the rear wheel and is fixed by a disc brake bracket.

## Parking stand

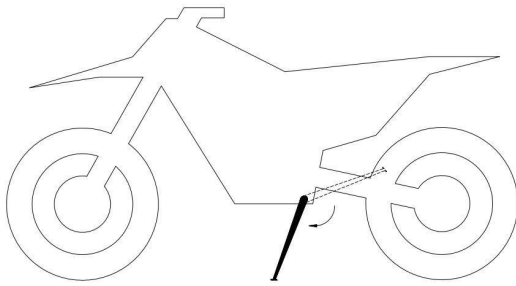

The 21 TT140 uses a single stand for parking. The single stand is on the left side of the motorcycle. When in use, straighten the motorcycle, kick the single stand to expand it, and tilt the motorcycle to the left so that the single stand touches the ground and supports the motorcycle.

## Notes before use

### Suggestions for first-time users

1. Please read this manual before driving, especially sections "complete vehicle handling" and "riding instructions".
2. Please perform Normative running-in before riding.
3. If any parts problems are found in use, please refer to this manual for repair or contact the dealer.
4. After each use, the motorcycle needs to be cleaned with water.
5. Do not drive in inclement weather (e.g. rainstorm, blizzard, etc.) unless necessary.
6. The company is not responsible for any vehicle problems caused by malicious acts.

### Running-in process

Motorcycle engines have many parts that make relative movements, such as pistons, piston rings, cylinder blocks, and meshing transmission gears. Therefore, in the initial stage of use, the engine must be regularly run-in. The running-in can adapt the moving parts to each other, correct the working gap, and form a good smooth friction surface that can withstand large loads. Only after the running-in engine is standardized can it have excellent performance and reliability.

The recommended running-in steps are as follows:

1. 0 ~ 2.5h stage: when using a motorcycle at 50% ~ 75% throttle, the speed should be changed frequently to

avoid the motorcycle running at the same throttle for a long time; after each hour of work, let the engine cool for 5 ~ 10 minutes; Avoid rapid acceleration, and the throttle cannot be either too large nor too small.

2. 2.5 ~ 4h stage: work under 50% ~ 75% throttle, at this time, the motorcycle can run at the same throttle for a long time. During the work, the throttle can reach 100%, but the duration is not higher than 5-10 seconds;

3. 4 ~ 5h stage: Use motorcycles at 75% ~ 100% throttle.

4. Above 5h: Increase the speed to 60 ~ 80km / h, knowing that the engine performance can be fully exerted.

**DANGER:** When driving a motorcycle, please do not accelerate at all costs. This behavior can easily lead to engine damage and safety accidents. Therefore, please pay attention to certain driving skills when using a motorcycle.

## Riding guide

### Checking items before riding

1. Check the fuel level in the tank
2. Check the oil level in the oil cup of hand brake
3. Check the oil level in the oil cup of foot brake
4. Check the foot brake clamp pad
5. Check the hand brake clamp pad
6. Check braking effect of braking system
7. Check the chain
8. Check rear sprocket, engine sprocket and chain guide
9. Check the chain adjuster
10. Check the surface of tires
11. Check tire pressure
12. Check the battery power
13. Check the thickness of the front disc brake
14. Check the thickness of the rear disc brake
15. Check the torque of each fastener
16. Check the engine gear
17. Check the cover
18. Check the fuel tank switch
19. Check protective gear if it is fully worn

## Notes when ignition

Kick starting steps are as follows:

1. Turn the oil tank switch to the "ON" position;
2. Pinch the brake handle with the right hand;
3. Step the right foot on the starting lever vigorously;
4. The engine starts and process ends.

## Notes when starting

1. Before starting, inspection should be carried out first, including the state of the vehicle and the driver's clothing.
2. When starting the vehicle speed should not be too fast.
3. For safety, please start in gear 1.

## Notes when cornering

1. Slow down in advance when cornering.
2. When cornering, lower center of gravity to reduce side-way.
3. When cornering, do not shift gears.

## Notes when acceleration

1. Do not accelerate on the corners.
2. After acceleration, shift gears in time.

## Notes when gear shifting

1. Do not increase the throttle while shifting gears
2. Do not shift gears on the corners.

## Notes when braking

1. When braking, the foot brake should be the main; hand brake as a supplement.
2. The level of the brake fluid in the brake fluid cup should be checked frequently.
3. When the brake fluid is insufficient, appropriate brake fluid should be added according to the maintenance manual in time.

## Notes when parking

1. When parking, slow down first and then stop. Do not brake in a sudden
2. When parking, expand the side stand and tilt the motorcycle to the left for parking.
3. Please put the gear in neutral before stopping.

## Maintenance Periodic Table

	Every 30 hours
	Every 20 hours
	Every 10 hours/after racing
	Once after 1 hour riding

Check and charge the battery		•	•	•
Check the front disc brake pads		•	•	•
Check the rear disc brake pads		•	•	•
Check the front and rear disc brakes		•	•	•
Check the brake hose for damage or leaks		•	•	•
Check the rear disc brake fluid level		•	•	•
Checking the free stroke of the brake pedal		•	•	•
Checking the frame		•	•	•
Check shock top		•	•	•
Check shock connecting rod		•	•	•
Check the surface of the tires	○	•	•	•
Check tire pressure	○	•	•	•
Check if the rim bearing is loose		•	•	•
Check the rim		•	•	•
Check for rim edge runout	○	•	•	•
Check spoke tension	○	•	•	•
Check the chain, rear sprocket, engine sprocket, chain guide and chain cover		•	•	•
Check chain tension	○	•	•	•
Oil all moving parts (such as chains, handles, etc.) and check for smooth operation		•	•	•
Check the front disc brake fluid level		•	•	•
Checking the free stroke of the hand brake lever		•	•	•
Check if the steering head bearing is loose	○	•	•	•
Check valve clearance	○			•
Check clutch			•	
Change the gear oil	○	•	•	•
Check all hoses (such as fuel, exhaust, etc.) and bushings for cracks, leaks, and incorrect wiring	○	•	•	•
Check cables for damage and sharp bends		•	•	•
Clean the air cleaner and air cleaner case		•	•	•
Check if the screws and nuts are tight	○	•	•	•
Replace the air filter				•
Check the carburetor idle speed	○	•	•	•

Final inspection: check if the vehicle is running safely and test run



- One time interval
- Periodic interval

**Note:** This table is for reference only. Please adjust the specific cycle according to the use of the motorcycle.

**Warning:** For inspection, adjustment and replacement of engine parts, please consult Kayo

## Suspension system setup

Check the compression and rebound of the motorcycle when riding

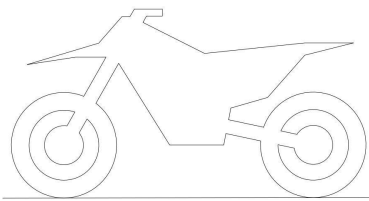

To ensure the best riding characteristics and avoid damage to the awing arm, shocks, rocker arms and frame, the basic setting of the suspension components must match the rider's weight.

The standard weight of rider for 21 TT140 off-road motorcycles is shown in the table below.

21 TT140	30~50kg
----------	---------

If the rider's weight is above or below the standard range, the basic setting of these sections must be adjusted accordingly.

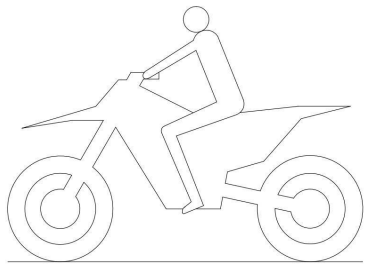

Measure distance from center of rear wheel to rear fender in suspension

The measurement procedure is as follows:

1. Set up the whole motorcycle, so that the rear wheel is completely suspended.

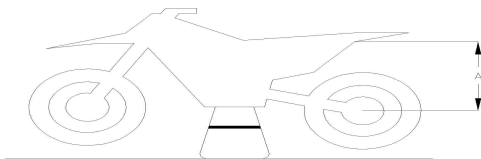

2. Select a fixed point on the side of the rear mud-guard and mark it as "Point 1".

3. Measure the distance from "Point 1" to the center of the rear axle and record it as "A1".

4. Lower the motorcycle from the rack

Measure distance from center of rear wheel to rear fender under no load

The measurement procedure is as follows:

1. Righten the motorcycle so that the center of the tire is perpendicular to the ground.

2. Measure the distance from the center of the rear axle of the motorcycle to "Point 1" and record it as "A2".

3. Use side stand to support the whole motorcycle

4. Calculate the difference between "A1" and "A2" and denote it as "D1".

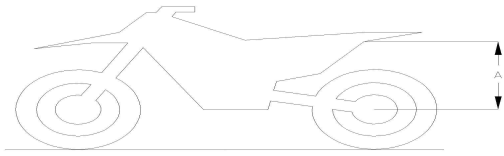

The D1 value of 21 TT140 is shown as follows,

	D1
TT140	10~40mm

### Measure distance from center of rear wheel to rear fender in riding condition

The measurement procedure is as follows:

- 1.The rider rides the motorcycle (engine does not start)
- 2.Righten the motorcycle so that the center of the tire is perpendicular to the ground.
- 3.Measure the distance from the center of the rear axle of the motorcycle to "point 1" and record it as "A3".
- 4.The rider uses side stand to support the motorcycle and leave the seat cushion.

Calculate the difference between "A1" and "A2" and denote it as "D2".

The D2 value of 21 TT140 is shown as follows,

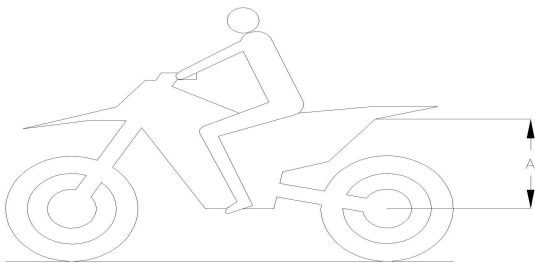

	D2
TT140	55~110mm

If "D2" measured by the customer is lower than the factory value, the spring preload can be lowered appropriately; If measured "D2" is higher than the factory value, the spring preload can be adjusted higher; If "D2" is far less than the factory value, it is necessary to replace the spring with a lower hardness; If "D2" is much greater than the factory value, it is necessary to replace the spring with a greater hardness.

### Adjust the spring preload of the rear shock



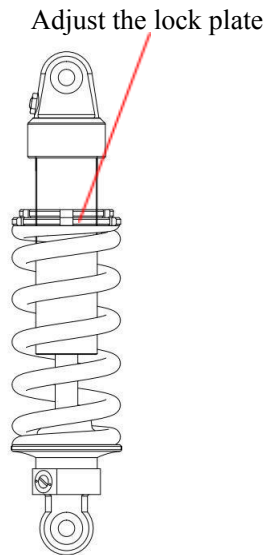

The spring preload of the rear shock can be controlled by adjusting the lock plate. Adjust the lock plate downward, the spring preload increases; Adjust the lock plate upward, the spring preload is reduced.

### Check the setup of the front shock

The measurement procedure is as follows:

1. Place the whole motorcycle on the ground.
2. Righten the motorcycle.
3. Hold the handlebars with both hands and press down the front shock.
4. Observe the effect of reduction and rebound.

### Adjust handlebar



The handlebars of the motorcycle can be adjusted according to customers' riding habits. The specific steps are as follows:

1. Remove the pad and cover from the handlebar.
2. Unscrew the press bolt so that the handlebar can rotate.
3. Sit on the motorcycle and adjust the handlebars to the natural position of your hands.
4. Tighten the press bolt
5. Check the handlebar position, if not satisfied, repeat the above process.

## Maintenance

### Placement of motorcycle

When carrying out the related maintenance of the motorcycle, it is necessary to suspend the motorcycle to facilitate the disassembly and assembly of the parts.

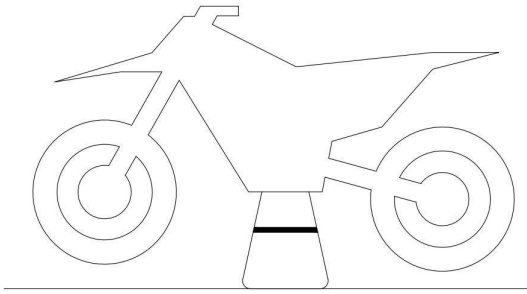

### Disassembly and assembly of front shock protector



Steps of disassembly and assembly of front shock protector are as follows:

1. Disassemble the fixing screws of front shock protector.
2. Disassemble the oil pipe clamp of front brake.
3. Disassemble the front shock protector.
4. Assembly shall be carried out in the reverse order of disassembly.

### Disassembly and assembly of front disc brake



Steps of disassembly and assembly of front disc brake are as follows:

1. Disassemble the mounting bolt of disc brake clamp.
2. Disassemble the oil pipe clamp.
3. Disassemble the brake lever.
4. Disassemble the front number plate wire clamp.
5. Remove the front disc.
6. Assembly shall be carried out in the reverse order of disassembly.

**Note:** Disc brake cover should be removed first when KT250 is dismantled.

### Disassembly and assembly of front shock



Disassembly and assembly of clamp

Steps of disassembly and assembly of front shock are as follows:

1. Disassemble the front disc brake.
2. Disassemble the front wheel.
3. Loosen the fixing bolt on the clamp.
4. Remove the front shock.
5. Assembly shall be carried out in the reverse order of disassembly.



Check the head steering

Steps of disassembly and assembly of clamp are as follows:

1. Disassemble the front shock.
2. Disassemble the steering column nuts.
3. Disassemble upper and down clamp.
4. Disassemble the adjusting nut of the steering column.
5. Remove the lower clamp.
6. Disassemble the steering column.
7. Assembly shall be carried out in the reverse order of disassembly.

Steps of head steering checking are as follows:

1. Suspend the motorcycle
2. Steer the motorcycle head through the handlebars. If the motorcycle head steers smoothly and there is no obstruction, the motorcycle head steers normally
3. If it is found that there is a sense of delay and obstruction in head steering, remove the clamp to check whether the steering bearing is normal.

Lubrication and installation of steering head bearing

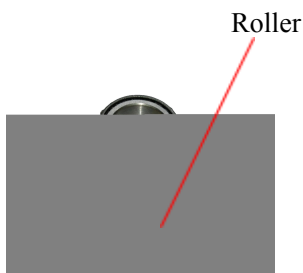

The steering bearing of the front should be coated with a layer of lithium grease on the surface of the roller when it is installed. Refer to the picture on the left for specific installation.

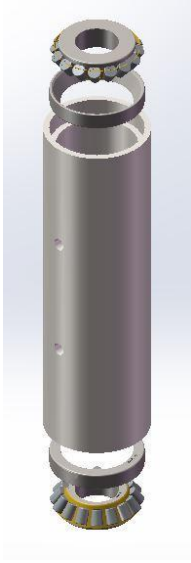

### Disassembly and assembly of front fender



Steps of disassembly and assembly of front fender are as follows:

- 1.Remove the bolts.
- 2.Remove the front fender
- 3.Assembly shall be carried out in the reverse order of disassembly.

### Disassembly and assembly of rear shock

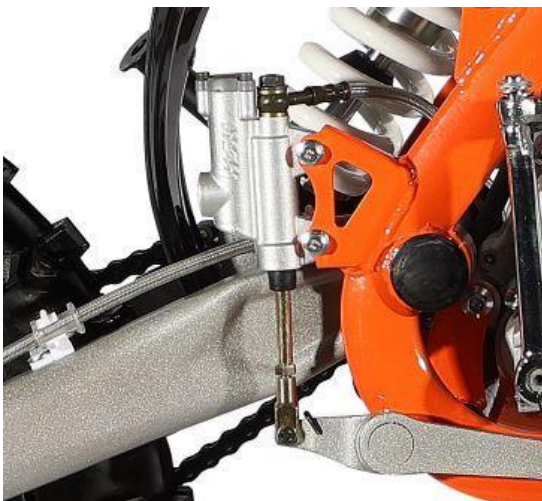

Check the rear shock and observe whether the spring has cracks. Replace rear shock if necessary.

Steps of disassembly and assembly of rear shock are as follows:

- 1.Remove the bolts of the rear shock and the frame;
- 2.Remove the bolt connecting the rear shock and the swing arm;
- 3.Remove the rear shock from the back after confirming no more interference.
- 4.Assembly shall be carried out in the reverse order of disassembly.

### Disassembly and assembly of seat



Disassembly and assembly of air filter

Steps of disassembly and assembly of seat are as follows:

- 1.Remove the bolts in the back of the seat;
- 2.Remove screws fixing the seat and the oil tank;
- 3.Pull out the seat backward and upward.
- 4.Remove screws fixing the seat and the plastic parts.
- 5.Assembly shall be carried out in the reverse order of disassembly.



Cleaning and maintenance of air filters

Steps of disassembly and assembly of air filter are as follows:

- 1.Loosen the hoop of air filter.
- 2.Remove the air filter.
- 3.Assembly shall be carried out in the reverse order of disassembly.

Before the maintenance of the air filter, it is necessary to inspect it as follows:

- 1.Check whether there are cracks on the surface of the air filter housing.
- 2.Check whether the air filter sponge is damaged.
- 3.Check whether the fire net is damaged.
- 4.Check whether the air filter shell is degummed with the sponge.

If the air filter is damaged, replace the corresponding parts; If no parts are damaged, maintenance should be carried out in the following way :

- 1.Clean the air filter hose with water and let it dry naturally.
- 2.Clean up the dust attached to the air filter sponge and soak the surface with the air filter oil. If the dust on the sponge is really difficult to deal with, you can also replace a new air filter sponge.
- 3.Use gasoline to clean the fire net and allow it to air dry naturally.
- 4.Flush air filter housing with water and allow to air dry.

Disassembly and assembly of exhaust pipe



Disassembly and assembly of muffler

Steps of disassembly and assembly of exhaust pipe are as follows:

- 1.Remove the muffler.
- 2.Remove the bolts fixing on the exhaust pipe.
- 3.Remove the spring.
- 4.Remove the fixing nut at the connection of engine and exhaust pipe.
- 5.Remove the exhaust pipe
- 6.Assembly shall be carried out in the reverse order of disassembly.

The exhaust pipe and muffler can guide gas emission and reduce noise.If the exhaust pipe is broken or damaged due to





rust or impact, please replace the new one immediately. If the noise is too high or the engine performance degrades, replace the muffler. For the cleaning of the exhaust system, please consult with KAYO dealer.

If you need to replace the muffler, please follow the following steps:

1. Unscrew the fixing nut of muffler.
2. Unscrew the fixing bolt of muffler.
3. Loosen the connection buckle between the muffler and the exhaust pipe;
4. Pull backward the muffler.
5. Replace the muffler and install the fastener;
6. Assembly shall be carried out in the reverse order of disassembly.

## Disassembly and assembly of fuel tank

Disassembly and assembly of fuel tank

1. Remove the seat.
2. Unscrew the bolt at the back of fuel tank.
3. Unscrew the bolt in the front of fuel tank.
4. Remove the fuel tank from the frame.
5. Assembly shall be carried out in the reverse order of disassembly.

Check the chain and clean



The checking of the chain is carried out from the following aspects:

1. Inspect the chain from the back of motorcycle to see if the chain is skewed.
2. Turn the rear wheel by hand to see if the rear wheel turns smoothly.
3. Carefully check the chain clearance to see if there is sediment attached.

The chain cleaning steps are as follows:

Use special cleaning agent to wash the silt and oil in the surface and clearance of the chain, wait until the chain naturally dry, and then brush a layer of antirust oil on the surface of the chain.

## Disassembly and assembly of the chain



Steps of disassembly and assembly of the chain are as follows:

1. Remove the spring plate on the chain.
2. Remove the chain moving section.
3. Pull the chain out from under the sprocket
4. Assembly shall be carried out in the reverse order of disassembly.

## Check and adjust the chain tension

The chain transfers the power output from the engine to the wheels and makes the motorcycle move normally. It is an important part of the motorcycle. Therefore, the chain needs to be regularly checked and maintained to ensure

its normal use.

The chain tension can be adjusted according to requirements, as shown below:

- 1.The motorcycle is fixed so that the rear wheel is completely suspended;
- 2.Measure the distance between the back of the swing arm and the chain, the normal distance should be 30 ~ 40mm, about the width of two fingers. The distance is close to the normal distance, do not have to be very demanding;
- 3.Loosen the rear axle nut;
- 4.Find the position of maximum tension in the chain under the condition of satisfying the normal spacing;
- 5.Through the nut on the tensioner, using the notch on the tensioner and the lugs on the adjuster, make the two ends of the awing arm aligned;
- 6.Screw the tensioner nut;
- 7.Tighten the rear axle nut;
- 8.Check the maximum tension point and readjust the tension if necessary.

When checking the chain tension, in addition to the chain, the guide rail and sprocket of the chain should also be visually inspected.

When the chain is used excessively or the stretching amount exceeds 2%, the chain should be replaced, and the corresponding guide rail and sprocket should also be replaced. If the chain is only replaced without other parts, the service life of the new chain will be shortened due to the wear and tear of other parts caused by the old chain, and these parts will soon reach the limit of use, so that they have to be replaced. Therefore, even from an economic point of view, it is worthwhile to replace the whole chain drive system at the same time. The replacement parts should use the original production or authorized products of KAYO.

The chain needs to be lubricated regularly, see General Lubrication section for details.

**Note:** alternately wet and dry working conditions will greatly shorten the service life of the chain and its surrounding parts. Therefore, please choose the appropriate lubricant according to the correct lubrication method.

**Note:** if the chain needs to be frequently tension, or you find any signs of wear on the front sprocket, rear sprocket and chain, please contact KAYO dealer for a comprehensive inspection to avoid safety problems.

Inspect rear sprocket, engine sprocket and chain guide structure

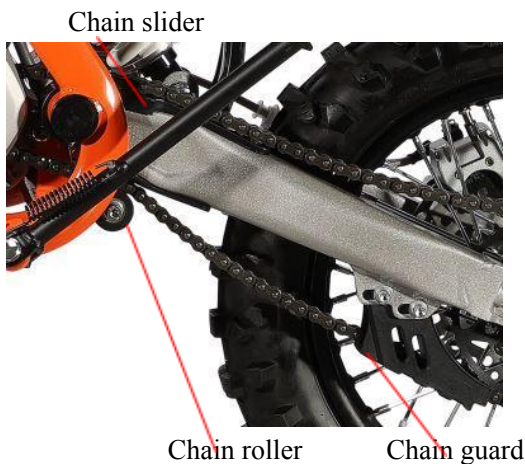

Check the wear of the chain slider and chain guard on the swing arm. Under normal circumstances, these two can play a role in guiding the chain movement, if the wear is too severe, it is not conducive to the normal movement of the chain, affecting its transmission function. So severely worn chain slider and chain guard should be replaced in time to ensure the normal work of the motorcycle.

### Inspection of the frame

The frame inspection work is carried out from the following aspects:

- 1.Check whether the paint layer on the frame surface is damaged;
- 2.Check whether the fixed points of the frame are deformed, especially the installation points of the engine, swing arm and rear shock;
- 3.Check whether there are cracks on the surface of the frame, especially in the welding parts of the frame.

### Inspection of the swing arm



Inspection of the throttle cable

The swing arm inspection is carried out from the following aspects:

1. Check whether there are cracks on the surface of the swing arm;
2. Check whether there is deformation at the rear shock installation point on the swing arm;
3. Check whether the paint layer on the swing arm surface is damaged.



Inspection of the handle bar

The throttle cable inspection is carried out from the following aspects:

1. Turn the throttle handle and feel if the throttle recoils smoothly
2. Start the motorcycle engine, turn the head left and right, and observe whether the engine power changes because of the head movement. If there is a change, it indicates that the throttle cable stroke is short.

Let the rider sit on the motorcycle with both hands on the handlebars naturally. Feel whether the position of clutch grip and brake grip is comfortable. If it is difficult to control, then the position of steering grip is determined.

## Check and maintain the brake system

### Check the free stroke of the front brake handle



The brake handle inspection is carried out from the following aspects:

1. The right hand rests naturally on the right handle
2. Use the forefinger and middle finger of your right hand to check for free movement. Both fingers should be able to hook and pull the handle
3. Pinch and release the handlebar and feel the resistance each time you do it.
4. If you feel soft when pinching, the oil pump or oil pipe may be mixed with air, at this time you should check the entire brake system and take appropriate measures

Inspection of the disc brake





Break disc

Check the fluid level of front brake disc



Refill the front brake disc fluid oil



Inspection of the disc brake

The disc brake inspection is carried out from the following aspects:

1. Check whether there are cracks, dents and other damage on the surface of the disc brake.
2. Measure the thickness of the disc and compare it with the limit thickness. If it is less than or equal to the limit thickness of the disc, the disc must be replaced immediately.

Disc brake limit thickness table is as follows:

	Front limit thickness	Rear limit thickness
TT140	3.0mm	3.0mm

21 TT140 uses hydraulic disc brake, and its disc brake fluid level can be checked through the observation hole.

If the liquid level is lower than the lower edge of the observation hole, the brake fluid should be immediately added to the upper edge of the observation hole.

The brake fluid must be checked and replaced regularly. If the brake fluid is mixed with water, soil or other particulate matter, the brake fluid should also be replaced.

DOT4 brake fluid is recommended

**Danger:** Do not mix different types of brake fluid into the brake system for use. The use of brake fluid must meet braking requirements. Do not use the brake fluid in an unsealed container. The brake fluid is liable to deteriorate when exposed to air, thus affecting the braking effect. Do not use used brake fluid.

**Note:** the brake fluid should be changed once a year even if the motorcycle is not used for a long time.



Front brake sheet

Check the caliper brake sheet thickness, if the thickness of the brake sheet is less than the minimum thickness, the brake sheet must be replaced.

The minimum thickness of a brake sheet is 1mm.

**Note:** the brake sheets should be replaced as a whole. If you are not sure to complete the replacement work, please go to the KAYO dealer, let the professional personnel to complete the replacement.

Check the free movement of the foot brake



Rear brake pedal:

Under normal circumstances, the free movement of the brake pedal should be shown in the table below. Check the brake lever and make sure the movement is correct.

Model	Brake pedal free movement
TT140	20~55mm

Check the rear disc brake fluid level



Refill rear disc brake fluid

Observe the fluid level hole and check the level of the brake fluid. The fluid level should be more than half of the observation hole, that is, the fluid level should be higher than the "LOWER". If brake fluid is insufficient, add it immediately.

**Note:** do not let the brake fluid splash on the paint surface, easy to cause corrosion.

**Danger:** please pay attention to check whether the brake fluid leakage, brake fluid tube is damaged. If there is leakage problem, please contact KAYO dealer.



The steps to refill brake fluid are as follows:

- 1.Remove lid screw.
- 2.Remove the lid
- 3.Add brake fluid to appropriate position
- 4.Install back the lid

DOT4 brake fluid is recommended.

Check the rear brake friction plate  
Friction plate

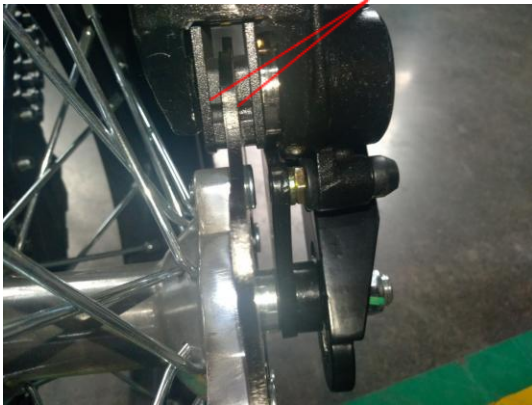

Check the thickness of the rear brake caliper brake disc, which should not be less than 1 mm. If the thickness of the brake disc is less than the minimum thickness, the whole set of brake discs should be replaced immediately.

**Danger:** If it is found that the brake system is worn too much, the corresponding parts should be replaced immediately to avoid safety accidents. The specific replacement should be carried out after consulting the dealer of KAYO.

Tire inspection and maintenance

Removal and installation of front wheel



The front wheel is removed in the following order:  
 Put the whole motorcycle on the stool and let it suspended  
 Remove the front disc brake cover (skip this step if there is no cover)  
 Loosen the front axle lock  
 Hold the front wheel in place with one hand and slowly pull out the front axle with the other  
 Remove the front wheel and place it in place  
 Assembly shall be carried out in the reverse order of disassembly.

Removal and installation of rear wheel



The rear wheel is removed in the following order:  
 Remove the chain  
 Loosen the rear axle lock  
 Hold the rear wheel in place with one hand and slowly pull out the front axle with the other  
 Remove the rear wheel and place it in place  
 Assembly shall be carried out in the reverse order of disassembly.

Check the outside surface of the tire

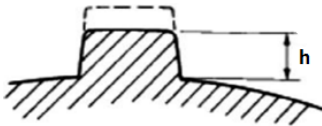

The steps for checking the tire surface are as follows:  
 1. Check the outside surface of the tire for scratches, holes  
 2. Check the tire tread height, if it is less than or equal to the minimum height, should immediately replace the tire.  
 Minimum tread height:  $h=3\text{mm}$ .

Check tire pressure

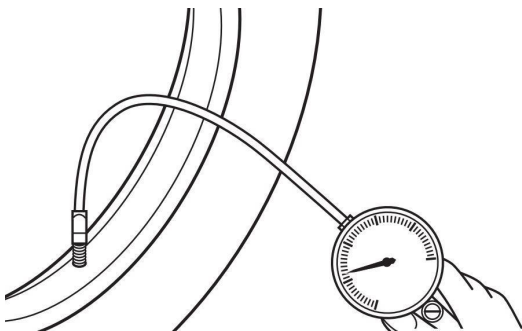

Use the pressure gauge to check whether the tire pressure level is in line with the standard. If the problem of low pressure often occurs, check whether the tire is leaking. If a tire is found to be flat, please contact the KAYO dealer.

Recommended pressure :

	Air pressure of front wheel	Air pressure of rear wheel
TT140	250kPa	250kPa

**Note:** The tire pressure should be checked under cooling condition.

Check the wheel spokes



Pull the adjacent spokes with your fingers to check whether the spokes lack tension. If any spokes are loose and weak, you must check all spokes of both wheels. If there are any problems, please contact the KAYO dealer.

## Engine installation

The steps of engine installation are as follows:

- (1) Hang the engine on the frame (take care to protect the exterior of the engine).
- (2) Install the carburetor on the manifold and tighten with nuts and bolts.
- (3) Install the throttle cable and air filter. The interface should be sealed. Install the clutch control cable.
- (4) Install the transmission chain.
- (5) Install the left rear cover or sprocket cover, tighten it with bolts, pay attention to magneto outlet.
- (6) Install exhaust muffler. The M8 nut and the exhaust pipe sealing ring should be firmly installed, and the tightening torque should be 25 ~ 30N•m. The exhaust port should not leak during the installation.

## Engine maintenance and adjustment

### Inspection of bolts and nuts of cylinder and cylinder body

Check at initial 1000km and every 5000km. When cooling engine, tighten bolts and nuts with torque wrench according to the specified torque.

Torque	M8	28~32N.m
	M6	10~15N.m



## Check valve clearance

Check at initial 1000km and every 5000km. Excessive valve clearance will lead to valve noise, while too small valve clearance will cause engine power reduction and valve damage. Valve clearance should be checked according to the above specified mileage and adjusted according to the following steps:

Remove the valve cover

Unscrew the magneto plug and timing plug on the left front cover and turn the magneto rotor with a 14mm socket wrench until the piston reaches the top dead center of compression stroke (turn the magneto rotor until the cut line on the rotor aligns with the timing hole on the left front cover).

Insert the standard gauge between the adjusting screws on the valve rod end and rocker arm, and the inlet and exhaust valve clearance is 0.03 ~ 0.05mm.

If the valve clearance is not within the range mentioned above, use a special tool to adjust it within the specified range.

Reinstall the valve cover, magneto plug and timing plug.

**Note:** The valve clearance should be checked and adjusted in the engine cooling condition.

## Inspection of compression pressure

Check at initial 1000km and every 5000km. The inspection steps is as follows:

Warm the engine by idling the engine.

Unscrew the spark plug.

Install the pressure gauge and connector into the spark plug mounting hole and make sure the connection is firm.

Turn the throttle handle to full open position.

Start the engine several times with the starter motor and read the maximum pressure of the engine cylinder as indicated by the pressure gauge.

standard values	1200~1400Pa
limit value	1100Pa

Low pressure indicates the following faults:

Excessive wear of cylinder walls.

Wear of piston or piston ring.

Piston ring stuck in ring groove. The valves are not properly engaged to the valve seat.

cylinder gasket damaged. When the compression pressure of the engine is lower than the above limit, the engine should be reassembled, inspected and repaired according to the specific situation.

**Note:** Before testing the engine compression pressure, make sure that the cylinder nuts and bolts are tightened according to the specified torque and the valve clearance is adjusted correctly.

## Adjustment of clutch control system

In order to ensure the correct use of the clutch and the portable operation, the user should ensure that the clutch is in the normal state of engagement, not allowed to be in a semi-clutch state.

## Adjustment around the engine

### Idle speed adjustment of carburetor

Throttle screw

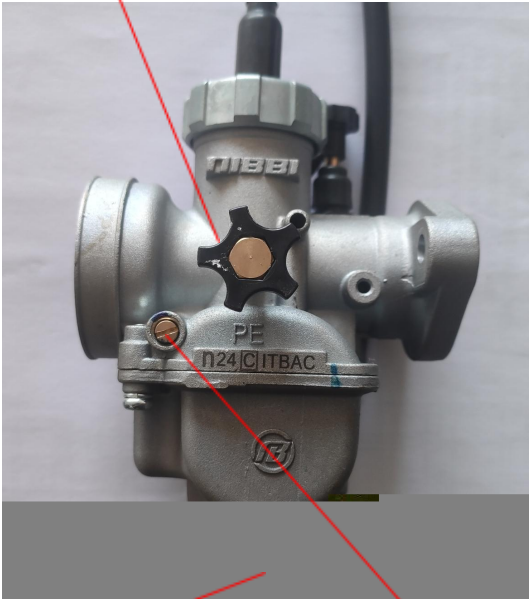

Carburetor drain screw Air screw

The throttle screw and air screw are used to adjust the idle speed of the carburetor. The steps are as follows:

1. Turn the air screw clockwise until it reaches the top of its stroke and reverse one and a quarter turns;
2. Adjust the throttle screw to ensure that the engine can run at a certain speed when the throttle handle is completely relaxed;
3. Adjust throttle screw to reduce engine speed as much as possible;
4. Adjust the air screw to make the engine speed as high as possible;
5. Repeat the above steps until you get a satisfactory speed;
6. Check that the throttle cable if it is working properly.

**Danger:** Driving a motorcycle with a broken throttle cable is certainly a very dangerous act. A normal throttle cable should have at least 10mm free travel. Start the engine and turn the handlebars left and right. If the engine stalls or accelerates due to the movement of the handlebars, the throttle cable should be improperly adjusted or damaged. Make sure the throttle cable is normal before driving the motorcycle.

### Clean the carburetor

The carburetor retains a portion of fuel after each ride. Therefore, the carburetor should be cleaned after each ride to avoid oil dirt, which affects the use of the carburetor. Carburetor cleaning methods are as follows:

1. A container is placed below the carburetor for receiving fuel oil
2. Close the oil tank switch
3. Unscrew the discharging bolt of the carburetor and wait for the fuel to flow out.
4. After the fuel is discharged, screw back the discharging bolt.

### Check shift lever position

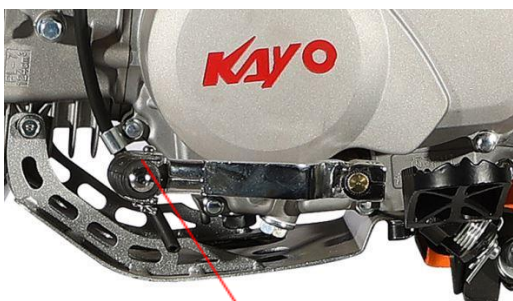

Shift head

### Adjust the position of the shift lever

Check the shift lever as follows:

1. Set up the vehicle so that the center surface of the tire is vertical to the ground.
2. The line of sight is same level with the pedal to observe the position of the shift head
3. The shift head should be same level with or slightly below the pedal.

If the shift head is higher than the pedal, the shift head should be adjusted downward; If the shift head is too much below the pedal, the shift head should be adjusted upward.

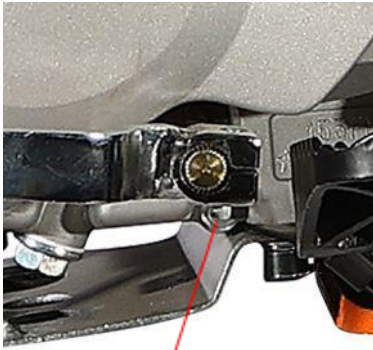

Shift lever fixing bolt

Check and replace spark plug



Adjust the shift lever in the following order:

1. Loosen the fixing bolt of the shift lever
2. Remove the shift lever
3. Turn the shift lever to the appropriate position and load the spline
4. Tighten the shift lever fixing bolt

Engine spark plug torque is 25 ~ 30N•m.

The spark plug must be removed periodically to check the distance between the electrodes (0.5 ~ 0.8 mm). If the spark plug contains oil or cinders, wipe it off with a wire brush or similar. The distance between the electrodes is measured with a meter and adjusted to prevent abnormal bending of the external electrodes. If the spark plug electrode is rusted, damaged, or the insulator is broken, the spark plug must be replaced.

**Note:** Spark plugs should be checked every 10 hours and replaced every 20 hours.

**Note:** If engine performance deteriorates, replace the spark plug to restore normal performance.

Lubrication system of engines

Selection of lubrication oil



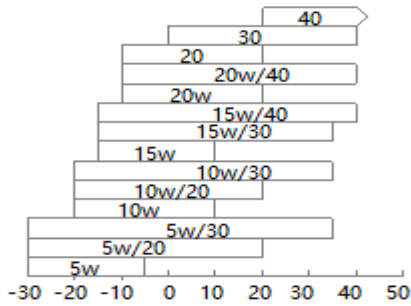

Lubricating oil is an important factor affecting engine performance and life. It must be selected according to the regulations. It is forbidden to replace with ordinary engine oil, gear oil and vegetable oil.

When the car leaves the factory, the transmission box is filled with 15W/40-SF grade oil. If other lubricating oil is used, its quality grade should reach SG or above, and the viscosity should be selected according to different regions and temperature changes, according to the attached drawings. When changing the lubricating oil, please run out the original lubricating oil in the crankcase, clean it with washing kerosene, and then add new lubricating oil according to the regulations.

### Lubricating oil inspection



Oil level gauge

If the engine is running, turn off and wait a few minutes for the oil to reach the bottom of the crankcase. Remove the oil gauge and observe through the oil gauge that the oil level should be between the upper and lower scales of the oil gauge.

If the oil level is higher than the upper scale, excess oil should be discharged.

If the oil level is below the lower scale, lubricating oil should be added.

### Lubricating oil replacement

When changing the lubricating oil, it should be carried out before the engine is warm and not yet cooled, so as to ensure that the lubricating oil in the crankcase can be quickly and completely discharged. When replacing, place an oil pan under the engine, and open the oil bolt A to discharge the oil. Check the plug gasket for breakage and replace it with a new one if it is. When the lubricating oil is completely discharged, install the oil discharge bolt and gasket and tighten them. Tightening torque: 15 ~ 20N·m refill new lubricating oil and check the oil position.

## Engine repair

### Cylinder and valves

#### Notes

- ◆ The camshaft is lubricated by the oil passage of the cylinder, and the oil passage can not have foreign matter entering. The camshaft bearing rotates flexibly and without clamping. The pressure reducing valve swing block rotates flexibly and can return to the normal position, otherwise it is easy to cause engine damage;
- ◆ Before installing the cylinder, the cylinder positioning pin must be assembled;
- ◆ When assembling, the cylinder camshaft hole, must apply the right amount of lubricating oil.

#### Main parameters and maintenance standards of cylinder parts

No.	Items	Standard valve	Maintenance limit	Remarks
-----	-------	----------------	-------------------	---------

			value	
1	Free length of valve spring	In32.75 Out35.55	In32.03 Out34.8	
2	Valve clearance	Intake valve	0.01~0.03	<0.01 or >0.03
		Exhaust valve	0.01~0.03	<0.01 or >0.03
3	Camshaft base circle runout	0.02	0.04	
4	Valve guide aperture	$\phi 5 \sim \phi 5.012$	$\phi 5.035$	
5	Valve stem diameter	Intake valve	$\Phi 4.97 \sim \phi 4.985$	$\Phi 4.96$
		Exhaust valve	$\Phi 4.955 \sim \phi 4.97$	$\Phi 4.94$
6	Clearance between valve rod and valve guide	Intake valve	0.013~0.04	0.07
		Exhaust valve	0.025~0.052	0.08
7	Width of valve sealing tape	1.5	/	
8	Flatness of cylinder head	0.04	0.05	
	Width of cylinder head valve seat face	0.8	/	

### Fault symptom and cause analysis

No.	Fault symptom	Cause analysis	Remarks
1	Low pressure in the cylinder	Valve clearance is too small	
		The valve seat is not tight	
		The valve timing is wrong	
		The valve spring is broken	
		Leakage of spark plug and cylinder head mounting parts	
		The cylinder head gasket combination is not tight	
		Crack or sand hole in cylinder head	
		Piston ring clearance is too large or broken	
		The piston has cracks or excessive wear	
		The inner diameter of the cylinder block is too large or sand holes	
2	Black smoke in the exhaust	Valve guide worn	
		Leakage or damage to oil cap	
		Piston ring clearance is too large	
		Leakage of cylinder head gasket assembly	
3	Excessive and abnormal noise	Valve clearance is too large	
		The valve is stuck or the valve spring is broken	
		Excessive wear of rocker arm	
		Incorrect valve timing	
		Camshaft wore	

### Removal of left cover of cylinder head

Small inspect hole

- 1.Remove the cylinder head left cover bolt,
- 2.Remove engine cylinder head left cover and left cover gasket,
- 3.Remove the cover of small and big inspect hole.



Left cover of cylinder  
Timing check

Big inspect hole

Timing mark of driven sprocket



Timing mark of cylinder head  
Magneto rotor timing scale



Engine left front cover timing mark

1. Use special tools to rotate C100 six level magneto locking nut, at the same time through the small inspect hole on the left front cover to observe the magneto rotor on the timing scale line and the left front cover on the timing mark is correct;
2. Observe whether the timing mark of the driven sprocket is aligned with the timing mark of the cylinder head from the left cover of the engine cylinder head.

## Removal of valve cover

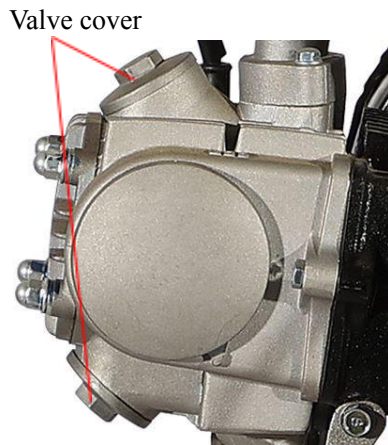

1. Remove the valve cover on both sides of the intake and exhaust of the cylinder head;
2. After removing the valve cover, check whether the thread is damaged and the sealing ring is damaged. If there is damage, use new parts when reassembling.

### Check valve clearance



1. Check that the magneto rotor timing mark is aligned with the timing mark on the left front cover and that the timing sprocket O mark is aligned with the cylinder head timing mark.
2. The valve should have slight axial clearance, no clearance up and down.
3. Valve clearance should be in the range 0.01-0.03mm.

### Removal of cylinder head

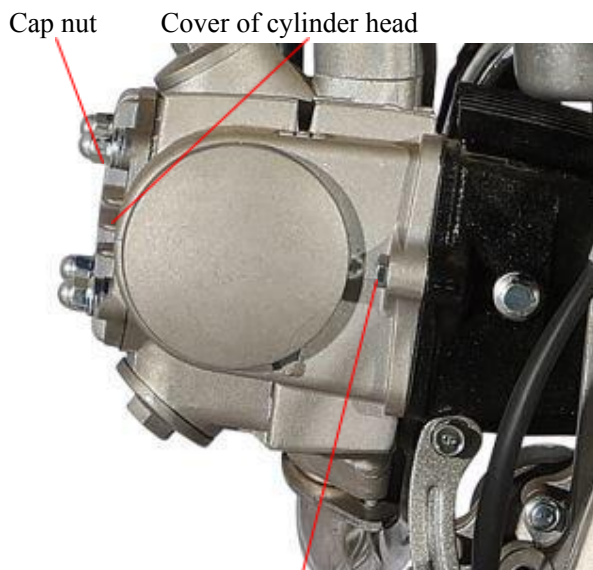

The removal steps of cylinder head are as follows:

1. Remove the 4 GB/T 923/M6 cap nuts securing the cylinder head cover;
2. Remove 3  $\phi 6.2 \times \phi 13 \times 2$  iron washers and 1  $\phi 6.5 \times \phi 13 \times 2$  copper washers;
3. Remove cylinder head and cylinder head gasket;
4. Remove left cylinder head cover;
5. Remove the 3 GB/T 5783/M5 $\times$ 12 hexagon bolts fastening the timing driven sprocket and remove the timing driven sprocket from the camshaft;
6. Remove 1 M6 $\times$ 20 bolt connecting the cylinder head and cylinder block;
7. Remove cylinder head;
8. Remove locating pins, flanging bushings and rectangular ring iron from A and B bolts and remove cylinder head gaskets.

Connecting bolts for cylinder head and cylinder block  
Disassembly of cylinder head



The disassembling steps of cylinder head are as follows:

- 1.Remove valve cover.
- 2.Remove 2 bolts GB/T 5787/ M6x20 fastening the right cover of cylinder head;
- 3.Remove the right cylinder head cover and the right cylinder head cover gasket;
- 4.Take out the intake and exhaust rocker arm shaft, intake and exhaust rocker arm, limit plate and camshaft assembly;
- 5.Press down the valve spring with the valve remover and remove the valve lock clip
- 6.Release the valve remover and remove the valve spring seat, valve spring and valve

**Notes:**

- 1.In order to prevent the permanent deformation of the valve spring, the valve spring can not be excessively compressed, just remove the valve lock clip.
- 2.All the parts removed should be marked to ensure that they reach the original assembly position during assembly.
- 3.When removing the gasket, ensure that it is in good condition. If it is damaged, replace it with a new one during assembly to avoid engine oil leakage.

Inspection of valves and valve springs

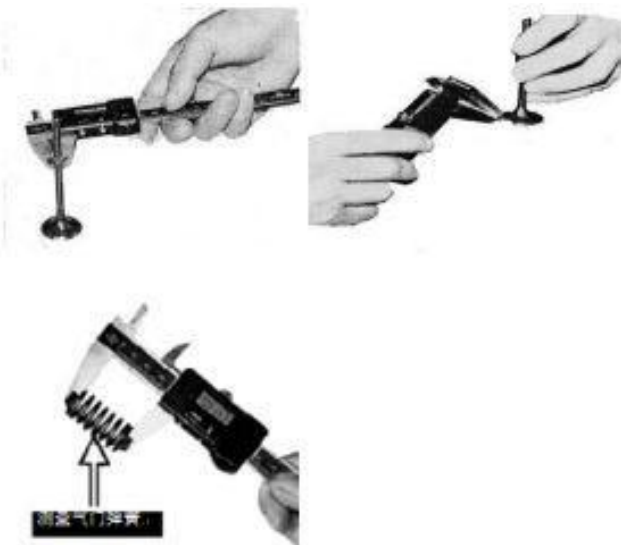

Valves and valve springs are checked as follows:

- 1.Check the valve for bending or abnormal wear of the valve stem and measure the outside diameter of the valve stem. Maintenance limit value:

Intake :  $\phi 4.96\text{mm}$

Exhaust :  $\phi 4.94\text{mm}$

- 2.Maintenance limit value of contact surface width:1.5mm

- 3.Check the valve spring for abnormal wear and measure the free length of the spring:

standard values: outer valve spring 35.55mm

Inner valve spring 32.78 mm

Maintenance limit value:outer valve spring 34.80mm

Inner valve spring 32.03mm

**Note:** Valve should be replaced if the valve contact surface is rough, uneven abrasion or abnormal contact with the valve seat or cannot guarantee sealing performance.

Inspection of rocker arm and rocker arm shaft





Inspection of camshaft components

The inspection steps of rocker arm and rocker arm shaft are as follows:

1. Check whether the rocker arm arc surface is damaged, whether the valve adjustment screw and nut rotate flexibly, if wear and damage are serious, it is necessary to replace the rocker arm;
2. Check whether rocker arm shaft has wear phenomenon, if the wear is serious, it is necessary to replace a new rocker arm shaft;



The camshaft convex has no obvious concave and convex feeling when touched by hand

Inspection steps for camshaft components are as follows:

1. Check whether the camshaft peach tip and base circle have wear phenomenon, whether the camshaft bearing rotation is flexible, if the phenomenon of wear or bearing rotation is bad, it should be replaced with new camshaft parts;
2. Check whether there is a crack in the pressure reducing valve swinging block combination, the spring does not rebound, and whether the centrifugal swinging block of the pressure reducing valve and the core shaft are loose. If so, it is necessary to replace the pressure reducing valve swinging block combination

Inspection of cylinder head



Check the cylinder head as follows:

1. Check whether the sealing of the cylinder head is good, if the sealing of the cylinder head is poor, it should be replaced with a new cylinder head or valve;
2. Check spark plug hole and valve seat for cracks;
3. Check whether the cylinder head is deformed, and check the flatness of the cylinder head with knife edge ruler and feeler ruler;
4. Check whether the oil cap is damaged.

Check and grind valve seats



Check and grind the valve seat as follows:

The carbon deposit in the combustion chamber is completely clean, evenly smear a thin layer of red oil on the valve seat, put the valve on the valve seat gently tap the valve not to rotate, and then pull out the valve, if the contact trace on the valve working surface is intermittent, the valve seat should be ground and repaired.

When grinding, first remove the carbon deposit on the inlet and exhaust valve seat, then apply the abrasive on the valve seat, and then suck the valve with the grinding tool of the rubber head, and grind the valve seat.

Inspection of valve guide



Measure the inner diameter of each valve guide with a dial indicator and record it. Maintenance limit value:  $\phi 5.035$  mm

**Note:** Before measuring the id of the valve guide, the carbon deposit in the valve guide should be completely removed.

If the valve guide needs to be replaced, the valve seat should be re-ground surface treatment, and the valve inserted into the guide, observe its movement, and finally calculate the clearance between the valve rod and the valve guide.

Valve clearance maintenance limits:

Intake: 0.07 mm; Exhaust: 0.08mm.

## Replacement of valve guide

1. Put the cylinder head in the thermostat to heat to 100 ~ 150 degrees Celsius, take out and support the cylinder head (pay attention not to burn), remove with the valve. Install the tool and punch the valve guide to the side of the rocker arm chamber.

2. Press the new valve guide into place and reaming the newly installed valve guide after the cylinder head cools.

3. The cylinder head is cleaned with cleaning agent and the metal chips in the cylinder head are removed with compressed air.

**Note:** Do not damage the cylinder head when removing the valve guide.

**Note:** when reaming, apply cutting oil on the reamer, and rotate the reamer when loading or taking it out.

## Measure width of valve seat contact area

1. Measure width of valve seat contact area. Maintenance limit value: 1.5mm

2. If the valve seat is too wide, too narrow or dented, the valve seat should be ground to achieve the correct degree of sealing.

3. When grinding the valve, use the electric gun sleeve on the rubber hose (with a tight fit), and then the valve rod sleeve on the rubber hose, the grinding graphite paste coated on the valve sealing belt, and then attached to the valve seat sealing line, start the electric gun, turn the valve, the valve and the seat ring with grinding.

4. After grinding, check whether the sealing line between valve and seat ring has been ground out, otherwise, regrinding should be done. Truthfully, the valve or cylinder head should be replaced if the grinding is not in place.

## Assembly of cylinder head



1. Install the oil baffle on the valve guide;

2. After the inlet and exhaust valve rod is coated with lubricating oil, load the valve guide, install the valve spring, valve spring seat and valve lock clip;

3. Press the valve spring with the valve remover, and then clamp the valve lock into the valve spring seat;

**Note:** To prevent permanent deformation of the valve spring, do not compress the spring too much to fit the valve lock clip.

4. Check whether the valve lock clip assembly is in place;

5. Conduct air tightness test on the assembled cylinder head assembly. If there is no leakage of the cylinder head assembly, proceed to the next step.

6. The camshaft into cylinder head CAM shaft hole and assembly in place, then turn the CAM CAM direction downward, rocker arm curved surface on the base circle of the camshaft in the rocker, rocker arm shaft outward

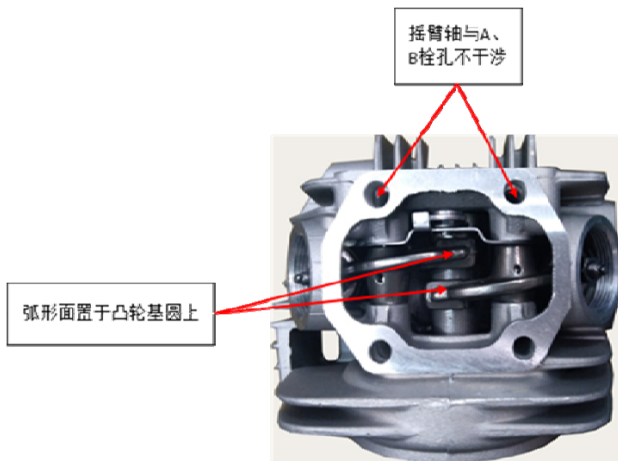

### Installation of cylinder head



through the threaded end of cylinder head rocker shaft hole smooth load limit in the plate and the rocker shaft hole, check rocker arm shaft load in place, can't interfere with AB bolt holes, Align the right cover of the sealing gasket and cylinder head with the mounting screw holes and mount them in place, and then tighten the bolts;

7. Inject 3mL-5mL clean oil into the rocker arm oil hole, the R surface of two rocker arms and the joint of the camshaft.

Note:

1. When installing rocker arm shaft, the thread end of rocker arm shaft is outward.
2. After the cylinder head is installed, turn the CAM, and the CAM rocker arm should rotate flexibly without clamping phenomenon.
3. Cylinder head right cover bolt fastening torque: 10 ~ 14N·m,
4. When assembling the gasket on the right cover of the cylinder head, the large hole should be consistent with the oil passage hole on the right cover of the cylinder head.

The installation steps of cylinder head are as follows:

1. Remove the old cylinder head gasket and install the new cylinder head gasket, then install the positioning pin, flanging bushing and rectangular ring.
2. Pull the trap to TDC, then attach the timing driven sprocket to the timing chain. Timing sprocket O stamped upward.
3. Install the cylinder head on the bolt A and B, then load the cylinder head gasket, and then load the cylinder head cover. Place the iron washer and copper washer on the bolt A and B, then install the 4 cap nuts to tighten the cylinder head cover on the bolt A and B, and tighten them.

Note:

1. Dust and dregs should not be allowed to enter the cylinder;
2. Fastening torque of A and B bolt nuts: 13 ~ 16N.m;
3. The copper washer is assembled on bolt B at the oil passage.
4. Install the connecting screw of the cylinder head into the connecting hole of the cylinder head and tighten the fastening torque: 8 ~ 14N·m.

Adjust the timing sprocket with iron tag to align the timing sprocket O mark with the cylinder head timing mark notch, and align the magneto rotor timing scale line with the timing mark on the left front cover, align the timing sprocket hole with the camshaft screw hole, load the timing bolt GB/T5783 M5×12, and then tighten.

Timing adjustment method:

- (1) Remove the large and small viewing hole cover on





the left front cover;

(2) rotate the rotor of the magneto so that the rotor timing scale line "----" is aligned with the timing mark on the left front cover;

(3) After the timing mark is corrected, observe the O engraving of the timing driven sprocket and the timing mark on the cylinder head is corrected;

Only when both (2) and (3) are satisfied can the engine be in the correct timing position.

Note:

①When assembling the timing bolt, do not drop the bolt into the cylinder;

②Timing sprocket bolt torque: 7 ~ 11N·m.

6. Adjust the clearance between the inlet and exhaust doors and turn the crankshaft counterclockwise for two weeks to align the timing sprocket O mark with the cylinder head timing mark.

(1) Axial slight clearance, no clearance up and down;

(2) Check the valve clearance with the feeler, its value should be in the range of 0.01-0.03mm;

(3) tightening torque of the nut: 8 ~ 12N·m.

7. Combine the  $\phi 6 \times \phi 13 \times 2$  aluminum gasket with the hexagon pan head bolt GB5787 M6x110, put it through the hole on the right cover of the cylinder head into the threaded hole on the left cover of the cylinder head (gasket), and tighten the bolt, tightening torque: 8 ~ 12N·m

8. Put the O-ring into the groove of the valve cover, and then install the valve cover on the cylinder head and tighten, fastening torque: 8 ~ 12N·m.

9. Put the spark plug into the spark plug thread of the cylinder head and tighten it.

Fastening torque: 10 ~ 12N·m.

## Cylinder block and piston

### Matters needing attention

◆ Cylinder head lubricating oil is through the oil hole next to the left AB bolt of the engine to the cylinder head. Before installing the cylinder block, ensure that the oil hole next to the left AB bolt is unimpeded, otherwise it is easy to cause engine damage;

◆ Can not make dust or dust into the crankcase.

### Main parameters and maintenance standards of cylinder block and piston

No.	Items		Standard value	Maintenance limit value	Remark	
1	Cylinder block	Cylinder diameter	$\Phi 52.4 \sim \phi 52.41$	$\Phi 52.418$		
		Cylindricity	0.005	0.01		
		Flatness of cylinder	0.04	0.06		
2	Piston	Skirt diameter, H=7	$\Phi 52.375 \sim \phi 52.385$	$\Phi 52.36$		
		Pin holes diameter	$\phi 13.002 \sim \phi 13.008$	$\phi 13.017$		
		Clearance between the piston pin and the piston pin hole	0.001~0.012	0.025		
3	Piston ring	closed interval	First ring	0.1~0.25	0.4	

			Second ring	0.1~0.25	0.4	
			Oil ring	0.2~0.8	1.4	
		side clearance	First ring	0.03~0.06	0.08	
			Second ring	0.02~0.06	0.08	
4	Clearance between cylinder and piston			0.025~0.035	0.07	
5	Outside diameter of piston pin			$\phi 12.994 \sim \phi 13$	$\phi 12.985$	
6	Inner diameter of tip of connecting rod			$\phi 13.016 \sim \phi 13.027$	$\Phi 13.035$	
7	Clearance between connecting rod tip and piston pin			0.016~0.033	0.05	

### Fault symptom and cause analysis

No	Fault symptom	cause analysis	Remark
1	Low pressure in cylinder	Abnormal wear of cylinder block or piston ring	
2	Black smoke in the exhaust	Abnormal wear of cylinder block, piston or piston ring	
		The piston ring is not installed correctly	
		Scratches on the piston or cylinder wall	
3	Engine overheat	Excessive carbon accumulation in piston	
4	Knock or abnormal noise	The piston or cylinder is worn	
		Excessive carbon accumulation in piston	

### Removal of cylinder block

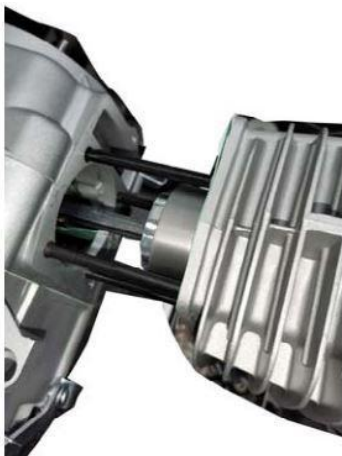

The removal steps of the cylinder are as follows:

1. Remove cylinder head;
2. Remove the fastening chain guide roller pin and aluminum pad  $\phi 8$ ;
3. Remove the M6x28 cross groove connecting bolts connecting the cylinder body and the crankshaft box;
4. Remove the cylinder body, cylinder body gasket and O-ring.

**Note:**

1. If the cylinder body gasket is damaged, the remaining gasket on the cylinder surface and the crankcase cylinder surface should be scraped clean with a scraper. Then replace with a new gasket. To prevent engine leakage after reassembly.
2. The gasket is easy to disassemble if it is immersed in gasoline. Avoid damage to cylinder contact surfaces when doing this.
3. The removed parts should be properly placed to avoid damage and loss.

### Inspection of cylinder block



Inspection steps of cylinder block are as follows,

1. Check whether the cylinder block is worn or damaged;
2. Measure the inner diameter of the cylinder block, take three positions, namely the top, middle and bottom of the piston stroke, and measure the two directions which are at right angles to each other.

Maintenance limit value:  $\phi 52.418\text{mm}$ .

### Removal of piston and piston ring

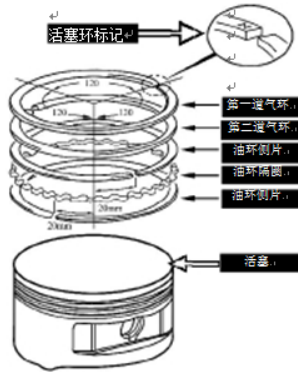

Piston and piston ring removal steps are as follows:

1. Remove the piston pin retainer using needle-nose pliers.
2. Remove the piston pin.
3. Remove the piston;
4. Remove the piston rings.

**Note:** do not drop the piston pin retainer into the crankcase when removing it

### Inspection of piston and piston ring

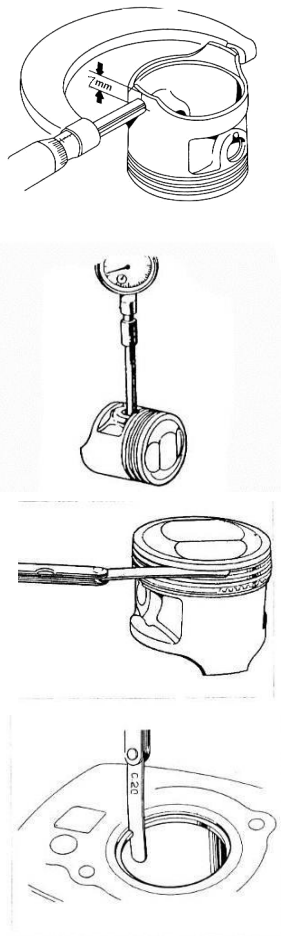

Piston, piston ring inspection steps are as follows:

1. Measure od 7 mm above piston skirt.  
Maintenance limit value:  $\phi 52.36\text{mm}$ ;
2. Calculate the cylinder clearance.  
Maintenance limit value: 0.1mm;
3. Measure the inner diameter of the piston pin hole.  
Maintenance limit value:  $\phi 13.017\text{mm}$
4. Check whether the piston and piston ring grooves are worn, and measure the side clearance between the piston ring and the piston ring grooves.  
Maintenance limit value: one ring: 0.08mm  
Second ring: 0.08mm  
Oil ring: 0.08 mm
5. Check the piston carbon deposition, if the carbon deposition is too much, clean up in time.
6. Load the piston ring into the cylinder and measure the closing clearance.  
Maintenance limit value: one ring: 0.4mm  
Second: 0.4 mm  
Oil ring: 1.4 mm
7. Measure the outside diameter of the piston pin.  
Maintenance limit value:  $\phi 12.985\text{mm}$
8. Calculate the clearance between the piston pin hole and the piston pin.  
Maintenance limit value: 0.025mm

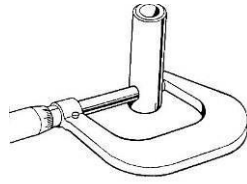

### Installation of piston ring

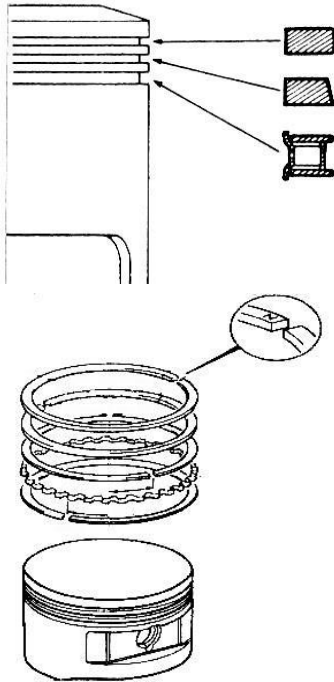

Piston ring installation steps are as follows:

1. Clean the piston ring groove;
2. Install the piston ring;

**Note:**

- (1) During installation, the piston and piston ring should be prevented from being damaged;
- (2) when installing the piston ring, one ring and two rings are literally facing the top of the piston, and the opening is staggered 180°, and the opening direction is toward the piston skirt direction; The opening of the two oil rings must be staggered 120° ~ 180°, and can not be aligned with the piston pin hole, and the piston rings should be flexible.
3. The gap between the rings in the oil ring should be matched with the gap of the isolation ring; When installing the oil ring, install the separator ring first, and then install the side guide rail.

### Installation of piston

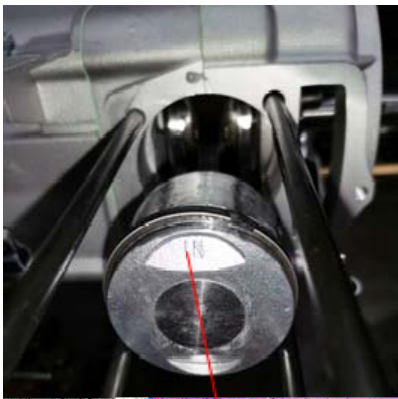

“IN” side of intaking air

The piston installation steps are as follows:

1. Install the piston, piston pin and a new piston pin retainer;
2. Apply appropriate amount of oil on the surface of the piston pin;
3. Then the piston inlet direction is arranged into the small end of the connecting rod upward, and the piston pin surface is coated with an appropriate amount of oil and inserted into the piston pin hole and the small end hole of the connecting rod;
4. Mount another piston pin retainer.

**Note:**

1. When installing the piston, the air intake (IN) direction is upward;
2. No deformation after assembly, the retaining ring completely falls into the groove, and the opening dislocation is more than 3mm;
3. If the piston pin retainer is seriously deformed, it must be replaced with a new retainer;
4. Do not let the piston pin ring fall into the crankcase;
5. There is slight clearance in the rear axial direction when the piston pin is assembled in place.

### Installation of cylinder block

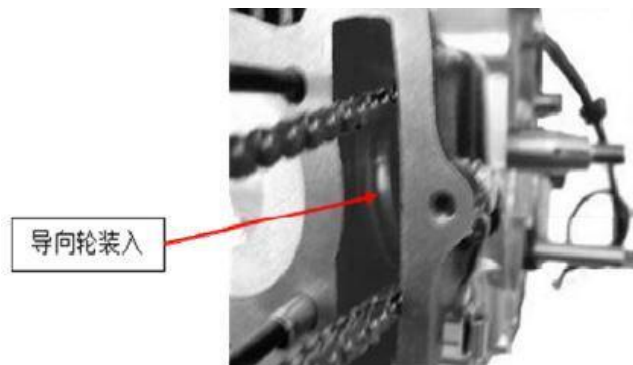

The installation steps of cylinder body are as follows:

1. Install cylinder block positioning pin, rectangular ring, new cylinder block gasket;
2. In the cylinder body, piston and piston ring surface evenly coated with a layer of oil;
3. The opening between the piston rings is staggered 120° each other, and then gently assemble the cylinder block in place;
4. Assemble the chain guide roller pin and aluminum gasket in place. Then load the chain guide roller into the cylinder body. The guide roller pin shaft passes through the cylinder body and the chain guide roller. Tighten the guide wheel pin shaft.
5. Tighten the bolts connecting the cylinder body and the crankshaft box body.

**Note:**

1. When installing the cylinder block, avoid damaging the piston ring.
2. The chain guide roller shall be located in the middle of the chain after loading into the cylinder body.

Clutch, driving gear, driven gear, oil pump, shifting mechanism

Matters needing attention

- ◆ After removing the right cover, the disassembly, installation and maintenance of the clutch, oil pump and shift mechanism can be carried out without removing the engine;
- ◆ The operation of the clutch, in case of failure, usually by adjusting the free stroke of the clutch handle and get a better correction.

Main parameters and maintenance standards

No.	Items		Standard value	Maintenance limit value	Remark
1	Clutch	Free length of spring	20.5	/	
		Free length of damping spring	21	/	
		Free thickness of the driving plate	2.85~2.95	2.5	
		Gap between cover and friction plate	0.1~0.3	0.5	
2	Oil pump	Radial clearance of inner and outer rotors	≤0.15	/	
		Clearance between rotor and cover face	0.04~0.1	/	

Fault symptom and cause analysis

No.	Fault symptom	Cause analysis	Remark
1	The clutch slips during acceleration	Insufficient free travel	
		Clutch plate bending	
		Clutch plate wore	
2	Too much pressure on the	Clutch cable bonded, damaged or unclean	



	handle	The clutch CAM disengaging mechanism is damaged	
3	Too low pressure in oil pressure	Oil pump failure The driving gear of oil pump is broken	
4	Difficult clutch operation	There are burrs in the chute of the clutch cover	
5	Shift difficult	Gear shifting arm bending The position of clutch cable is not adjusted correctly Variable speed drum positioning plate spring broken or elastic not enough	

### Removal of right trim cover



The steps to remove the right trim cover are as follows:  
 1. Remove the GB/T820-M6x22 cross-reckled countersunk screws from the right trim cover;  
 2. Remove the right trim cover.

### Adjustment of clutch stroke



Loosen the adjusting nut, turn the adjusting bolt clockwise,  
 The clutch camshaft small end free rotation stroke becomes larger, in the counterclockwise rotation adjustment bolt, while the clutch camshaft small end from  
 By the rotation stroke  $\geq 5\text{mm}$ , (can be adjusted according to the actual motorcycle), tighten the adjustment nut.

### Removal of right crankcase cover

Remove the right crankcase cover as follows:

1. Drain the oil (remove the oil drain plug M12x1.5 on the right side, and wait until the oil in the box runs out);
2. Remove the two GB/ T5777-M6x80, 1 fastening the right cover GB/T 5777-M6  $\times 65$ , 5 GB/T 5777-M6  $\times 40$  bolts, take down the right crankcase cover, right crankcase cover gasket and positioning pin  $\phi 8 \times 12$  two;
3. Remove the M6x12 cross countersunk screw fastening the plate assembly, and remove the clutch adjusting nut and bolt on the plate.
4. Remove the clutch camshaft and return spring, and remove the clutch push rod.

#### Note:

1. The clutch camshaft is equipped with 17 $\times$ 1.5 O-ring, please do not lose;
2. Do not drop the positioning pin into the crankcase body;
3. If the gasket on the right crankcase cover is damaged, clean the remaining gaskets on the right crankcase cover and right crankshaft box with a scraper. Then replace with a new gasket. To prevent engine leakage after reassembly.

### Clutch disassembly



The disassembly steps of the clutch are as follows:

1. Remove the through-tubing and the through-tubing spring;
2. Remove four M5x10 cross countersunk screws that secure the clutch end cover;
3. Remove the clutch end cover and gasket;
4. Pry open the locked clutch stop washer, remove the large round nut fastening the clutch, take off the butterfly washer, clutch stop washer;
5. Take out the clutch;
6. Remove the clutch driving gear jacket;
7. Remove the elastic retainer below the clutch, and take out the clutch upper plate, friction plate, friction plate, clutch driving plate, outer cover, shock absorption spring, spring in turn. (This step is not recommended to disassemble, because assembly after disassembly requires special equipment with press assembly), if the clutch is damaged, you can replace a new clutch.

### Disassembly of driving and driven gears

The disassembly steps of the driving and driven gears are as follows:

1. Remove the driving tooth (18 teeth), driving tooth shaft sleeve and driving tooth ring (3mm);
2. Remove the rear-ring of the driven gear and take out the driven gear (67 teeth).

**Note:** when removing the driven gear rear-ring, prevent the driven gear rear-ring from falling and falling into the crankcase.

### Removal of engine oil pump



The removal steps of the oil pump are as follows:

1. Remove one GB/T819/ M6x30, one GB/T819/ M6x35, and two GB/T819/ M6x35 cross-reckled countersunk screws for securing the oil pump.
2. Remove the oil pump, oil pump gasket and 2  $\phi$  8x12 positioning pins;
3. Remove the two bolts M5x12 of the cover plate of the oil pump, remove the spring washer of the oil pump, remove the washer and the cover plate of the oil pump;
4. Remove the internal and external rotors of the oil pump and the oil pump pin C2 2.5x10, and then remove the oil pump gear, oil pump shaft, oil pump body and oil pump pin C3x16.

**Note:** there are 1 oil pump pin  $\phi$ 4x7 inside and outside the oil pump, and the spring washer, washer and oil pump pin removed should be properly kept to avoid loss.

### Disassemble shift mechanism





### Inspection of right crankcase cover

用油封专用工装将油封装入后无卷边、切边，稍低于箱体端面



### Clutch inspection

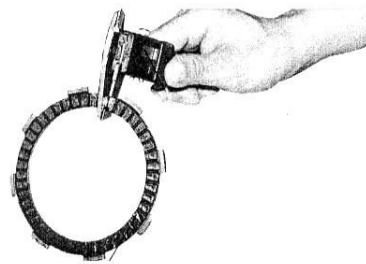
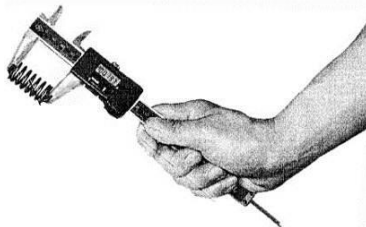

### Inspection of driving and driven tooth

Check whether the driving and driven driving teeth are worn and damaged. If the wear and damage are serious, it is necessary to replace the master and slave driving teeth.

The disassembly steps of the shift mechanism are as follows:

1. Remove the shift arm parts;
2. Remove the fastening screw GB/ T70.1Mx35 of the five-star plate and remove the five-star plate;
3. Remove the positioning plate assembly fastening screws, and remove the positioning plate spring and the positioning plate assembly.

Check the right crankcase cover as follows:

1. Check whether the oil seal of starting shaft and clutch push rod on the right crankcase cover is damaged. If the oil seal is found to be broken, a new oil seal should be replaced;

#### Attention when replacing oil seal:

- (1) Confirm whether the state of oil seal is correct, starting shaft oil seal 13.7×24×5, clutch push rod oil seal 12×21×4;
  - (2) When assembling, the marked face should be outwards
2. Check whether the clutch adjusting nut and the clutch adjusting bolt work properly  
Yes, the return spring is in good condition.
  3. Whether the right crankcase cover is broken and whether the oil channel is smooth. Replace the right crankcase cover if damaged

Clutch inspection steps are as follows:

1. Measure free length of clutch spring  
Maintenance limit value: 20.5mm  
Limit value of damping spring maintenance: 21mm
  2. Measure the thickness of each clutch friction plate. If the clutch friction plate shows scratches or faded marks, it should be replaced.  
Maintenance limit value: 2.5mm
  3. Check whether the surface of the clutch driven plate is distorted  
Maintenance limit value: 0.14mm
  4. Check the gap between the clutch cover and the friction plate  
Maintenance limit value: 0.6mm
  5. Check whether the groove on the drum type of the outer cover is notched or scarred due to the friction of the clutch disc. If it is serious, the outer cover needs to be replaced.
- Note:** If the clutch friction plate is burned, the friction plate should be replaced, and the clutch should be replaced seriously

## Check the oil pump

Check the oil pump as follows:

1. Check whether the internal and external rotors of the oil pump are worn and damaged. If the wear and damage are serious, it is necessary to replace the new oil pump rotor assembly;
2. Check the oil pump gear rupture phenomenon, there is a need to replace the new oil pump gear;
3. Check whether the cover of the right oil pump is worn and damaged. If so, it is necessary to replace the cover of the right oil pump.

## Check shift mechanism



## Assembly of shift mechanism

Shift arm positioning shaft

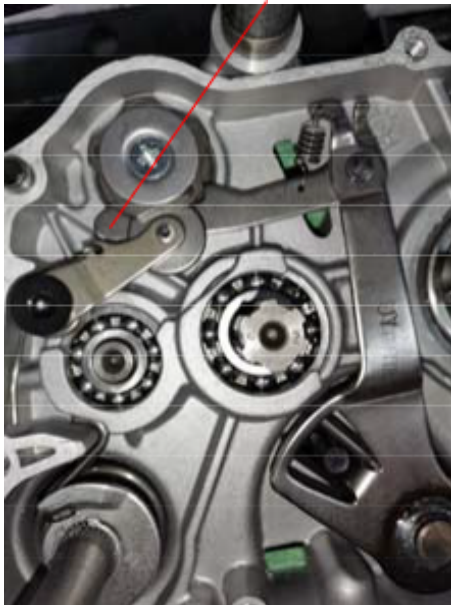

Check steps of the gear change mechanism are as follows:

1. Check whether the roller of the variable speed drum positioning plate rotates flexibly, whether the positioning plate is bent, and whether the spring is deformed;
2. Whether the big arm and forearm of the shift arm are deformed, whether the spring is deformed, and whether the shaft is bent.

The assembly steps of the gear shifting mechanism are as follows:

1. Slide the shift arm into the left and right crankshaft box hole, press down the shift arm assembly so that the forearm is stuck into the shift drum baffle plate;
2. The positioning plate spring hook in the positioning plate hanging groove hole and combination in place;
3. Move the big end roller of the positioning plate to the positioning pin of the speed shifting drum and tighten it in place;
4. There is slight clearance when the shift arm dial plate is moved by hand, and the clearance is uniform without unilateral phenomenon.

Note:

1. After the gear shifting arm is assembled, first test whether the gear shifting is correct, and then continue the installation after the gear shifting is correct;
2. Confirm that the spring is assembled in place and the positioning plate is flexible;
3. The main shaft rotates flexibly without clamping;
4. Move the spindle up and down to check the axial clearance of the spindle, which should be in the range of 0.3mm-0.5mm.

## Assembly of oil pump

The assembly steps of the oil pump are as follows:

1. First pass the oil pump shaft through the oil pump gear, and then load the oil pump pin into the pin hole combining the oil pump and the oil pump gear;
2. Pass the oil pump shaft through the oil pump body, and then the oil pump pin  
Load into the pin hole of the oil pump shaft, then load into the inner rotor and outer rotor of the oil pump,



finally load on the oil pump cover, install 2 M5x12 bolts, tighten. The washer of the oil pump is loaded on the shaft of the oil pump, and the spring washer of the oil pump is stuck on the pump.

3. Put the positioning pins into the positioning pin holes of the oil pump in the box, combine the oil pump with the sealing gasket and place them in the corresponding positions of the box, align the threaded holes, install two M6x30 cross pan head screws and one M6x35 cross pan head screws into the corresponding threaded holes and tighten them.

**Note:** after the assembly of the cover plate, ensure that the oil pump shaft rotates flexibly without clamping and the tooth surface is not damaged.

## Assembly of driving and driven teeth

The assembly steps of the driving and driven teeth are as follows:

1. In the right crank into the driving gear ring, driving gear sleeve and driving teeth (18 teeth);
2. Load the driven gear (67 teeth) on the spindle, and then clamp the rear-ring of the driven gear.

## Clutch assembly

The assembly steps of the clutch are as follows:

1. The clutch 4 springs into the clutch cover, in the clutch drive plate, in turn into the friction plate, clutch plate, friction plate, clutch plate. Use special equipment to put the clutch driving plate into the clutch elastic retaining ring, in the installation of 4 shock absorption spring;
2. Load the clutch driving gear jacket.

**Note:** two friction plate teeth should be aligned after clutch assembly.

## Installation of clutch



The installation steps of the clutch are as follows:

1. Put the clutch into the driving tooth on the right crank;
2. The clutch stop washer stop position and clutch keyway alignment into the butterfly washer convex surface into the stop washer, the large round nut into the stop washer and tighten;
3. Lock the lock plate of the lock washer into the key slot of the large round nut;

Align the screw hole on the clutch end cover with the screw hole on the clutch after combining the clutch end cover gasket and the clutch end cover. Take 4 pieces of cross countersunk screw M5x10 to lock the end cover. When locking the screw, pre-tighten it and then tighten it diagonally and in place. After assembly in place, the inner ring of the rotating bearing should rotate flexibly without clamping phenomenon.

5. Put the spring fitting clutch end cover on the through-tubing and through-tubing

**Note:**

1. Tightening torque of large round nut: 40 ~ 50N·m;
2. Tighten end cover screws to a torque of 5 to 8N·m.

## Assembly of right crankcase cover

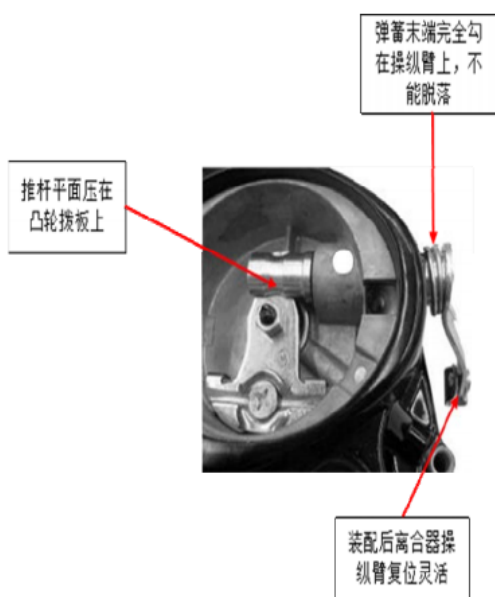

The assembly of the right crankcase cover is as follows:

1. Assemble the clutch push rod smoothly into the corresponding hole on the right box cover;
2. Screw the clutch adjusting nut into the adjusting bolt after more than 3 teeth, and put the adjusting bolt into the CAM plate to the threaded hole and tighten it;
3. The CAM dial plate is stuck into the flanging of the limit plate and assembled in place;
4. Place the adjusting bolt on the upper part of the push rod, align the screw holes on the limit plate with the threaded holes on the right cover, and tighten the M6x12 cross countersunk screw.
5. Clutch camshaft and return spring combination, through the right box cover mounting hole, half circle rod plane and CAM dial plate, spring end completely hook on the clutch camshaft, can not fall off, the positioning pin through the right box cover pin hole card into the clutch camshaft groove.

**Note:** the clutch camshaft is flexible and the push rod does not fall off.

## Assembly of right crankcase cover



The assembly steps of the right crankcase cover are as follows:

1. Load 2 positioning pins;
2. Remove the old right crankcase gasket and install a new gasket;
3. Assemble the right crankcase cover in place and secure it with 2 GB/ T5777-M6x80, 1 GB/T5787 \* M6x65 and 5 GB/T 5777-M6x40 bolts. Fastening torque: 10 ~ 14N·m.

## Right trim cover for installation



The installation steps for the right decorative cover are as follows:

1. Mount the right decorative cover;
2. Tighten the two GB/T 820-M6x22 cross-grooved countersunk screws.



## Magneto, timing chain

### Matters needing attention

- ◆ The removal and installation of the magneto, left cover and double teeth introduced in this section, as long as the left crankcase cover is removed, without removing the engine can be completed;
- ◆ For the inspection of magneto, refer to the methods in the section of battery charging system.

### Removal of left rear cover



The steps for removing the left rear cover are as follows:

1. Remove the bolts fastening the left rear cover;
2. Remove the left rear cover.

### Removal of left front cover



The steps for removing the left front cover are as follows:

1. Remove 3 GB/T 5787/ M6x32 bolts and 1 GB/T 5787/ M6x50 bolts from the left front cover.
2. Remove the left front cover;
3. Remove the left front cover gasket and two 8 x 12 positioning pins.

### Removal of magneto stator



The removal steps of the magneto stator are as follows:

1. Turn the left front cover over and place it on a flat surface;
2. Remove two GB/T 5787-M6x20 bolts for securing the stator of the magneto, two GB/T 5783-M5×12 bolts for securing the trigger, and one GB/T 818-M5× 61 cross-ricited pan head screw for securing the small press wire plate. 1 bolts GB/T 5777-M6 ×14 for fastening wire harness press plate;
3. Remove the stator of the magneto.

**Note:** If the stator of the magneto is subjected to accidental impact in the process of disassembly and assembly, such as the stator of the magneto is struck by a foreign body, it should be replaced with a new stator.

### Removal of magneto rotor



The removal steps of the magneto rotor are as follows:

1. Remove the locking nut of the magneto rotor;
2. Remove the rotor of the magneto with a special tool.

Note:

1. When the rotor of the magneto is removed, it can only be removed with special tools, and it is not allowed to knock the rotor of the magneto;
2. If the magneto rotor is subjected to accidental impact in the process of disassembly and assembly, such as the magneto rotor falls to the ground or is struck by foreign bodies, it should be replaced with a new magneto rotor.

### Removal of starting motor and starting sprocket



The removal steps of starting motor and starting sprocket are as follows:

1. Remove the two GB/T 5787/ M6x25 bolts fastening the starting motor;
2. Remove the starting motor;
3. Remove 1 hexagon head bolt GB/T 5783-M6×10 for fastening the starting sprocket press plate;
4. Remove the chain tension-plate, chain guide plate, starting sprocket and starting chain.

### Removal of transition plate



The removal steps of the transition plate are as follows:

1. Remove one GB/T 5777-M6x105 bolt, one GB/T 5777-M6x35 bolt, one GB/T 5777-M6x25 bolt and one aluminum washer for securing the transition plate.
2. Remove the transition plate.

### Removal of timing chain

The methods and steps of disassembling the timing chain are as follows:

Method one:

1. Remove the left cover of cylinder head;
2. Remove the three bolts fastening the timing driven sprocket;
3. Remove the chain guide roller pin fastening the chain guide roller on the cylinder body;
4. Remove the chain tensioning roller on the tensioning arm;
5. Remove the timing chain.

Method two:

1. Lower cylinder head and cylinder body;

2. Remove the timing chain.

Removal of tensioning arm, tensioning rod and

tensioning roller

The removal steps of the tensioning arm, tensioning rod and tensioning roller are as follows:

1. Remove the chain tensioning arm mandrel; Take out the tensioning arm;
2. Remove the tight sealing screw M14×1.5, take out the tensioning rod return spring and tensioning rod;
3. Remove the core shaft of tensioning roller and take out the tensioning roller.

Inspection of left front cover and left back cover

Check the left front cover and left back cover as follows:

1. Check whether the left front cover and left rear cover are damaged, and whether the left front cover gasket is damaged. If damaged, replace the left front cover, left front cover gasket and left rear cover.
2. Check that the appearance of the large and small viewing hole covers is not damaged, and the O-ring is not damaged or deformed. If damaged, replace the large and small viewing hole covers and o-ring with new ones.

Transition plate, starting motor, starting sprocket

inspection



Transition plate, starting motor, starting sprocket check steps are as follows:

1. Check whether the starting sprocket is damaged, whether the transition plate is damaged, whether the transition suct seal is damaged, and whether the transition plate O-ring is damaged. If there is damage, replace the new transition plate, the starting sprocket, the trans32ition suct seal and the transition plate O-ring starting motor gear is flexible;
2. Whether the starting sprocket meshes with the starting chain

**Note:** The transition suct seal and o-ring of the transition plate should be in good condition. If there is any damage, please replace the transition suct seal and O-ring of the transition plate to prevent oil leakage.

Magneto stator, rotor inspection



The inspection steps of magneto stator and rotor are as follows:

1. Check whether the magnetic tile of the magneto motor rotor is cracked or damaged, if so, it is necessary to replace the new magneto motor rotor;
2. Check to confirm that there is no foreign matter in the inner wall of the rotor, whether the roller of the rotor unidirectional roller falls off or is seriously worn, if there is, it is necessary to replace the new roller of the unidirectional roller;
3. Check whether the stator of the magneto is worn or damaged. If so, replace the stator of the magneto with a new one.

## Installation of tensioning arm, tensioning rod and tensioning roller

The small end of the tensioning rod spring is loaded inwards

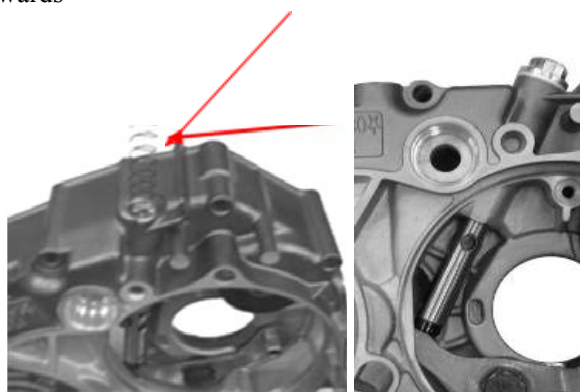

The installation steps of the tensioning arm, tensioning rod and tensioning roller are as follows:

1. Align the mounting holes of the tensioning roller with the mounting holes of the box body, insert the box body, take the core shaft of the tensioning roller through the tightening roller, and secure it in place;
2. Place the tensioning arm into the container and align the mounting holes with the mounting holes in the container. Insert the tensioning arm manshaft through the mounting holes of the tensioning arm bolts into the threaded holes in the container, and secure the tensioning arm in place.
3. Put the glue head of the tension rod inward into the box body, and then put the small end of the spring of the tension rod inward into the tension hole of the box body, and then put the gasket chamfer outward with the sealing plug into the tension hole of the box body and tighten it.

### Note:

1. Tightening torque of tension roller mandrel: 10-14N·m;
2. Tension-rod mandrel fastening torque: 12 ~ 16N·m;
3. Sealing screw fastening torque: 25-30N·m;
4. Tension arm and tension bar have flexible action without clamping.



拨动张紧臂确认张紧臂、张紧杆动作灵活无卡滞

## Transition plate installation

Transition plate installation steps are as follows;

1. Mount two sealing rings 6.8×1.9 on the left crankshaft box;
2. Put the O-ring into the positioning pin, and then into the left body;
3. Install the transition plate on the left container and tighten the bolts.

## Installation of starting motor and starting

### sprocket

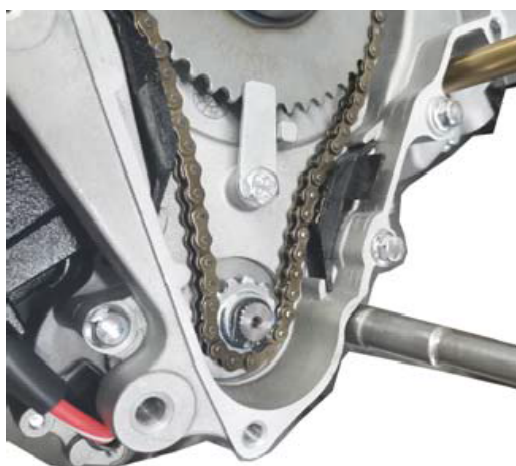

The installation steps of starting motor and starting sprocket are as follows:

1. After the starting sprocket is combined with the starting chain, the starting sprocket convex hull is loaded upward into the crankshaft and pressed into place, and the chain tensionplate and the chain guide plate are loaded;
2. The bolt passes through the starting sprocket pressing plate, the pressing plate protruding upward, the pressing plate pressing to the right tightly against the sealing oil pan limit column, and then tighten the bolt; Tightening torque: 10-14n·m
3. After the starting motor teeth engage with the starting chain, load the starting motor mounting hole on the transition plate, and load the bolt to tighten.

**Note:** the clearance between the starting sprocket press plate and the end face of the starting sprocket should be in the range of 1mm-2mm.

## Installation of magneto stator

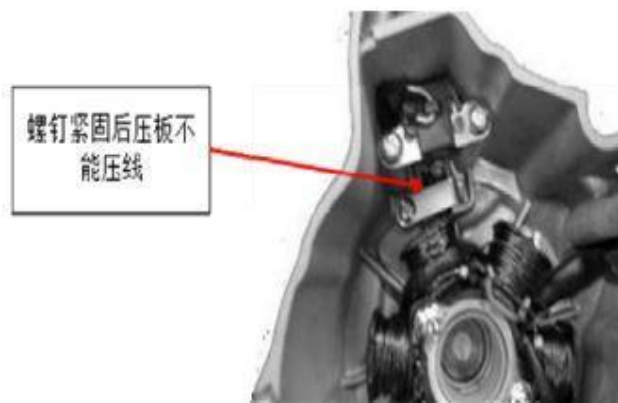

The installation steps of the magneto stator are as follows:

1. Put the left front cover of the stator of the magneto motor. After the stator is installed, align the screw holes with the threaded holes of the left front cover. Tightening torque: 10-14n·m
2. Align the mounting hole of the flip-flop positioning plate with the mounting hole of the left front cover and load the flip-flop into the left front cover, then load the bolt to tighten; Fastening torque: 6 ~ 8N·m
3. Assemble the bending face of the small line pressing plate and the screw of the pressing plate into the left front cover, and then tighten the screw; Fastening torque: 6 ~ 8N·m
4. Align the mounting holes of the wire harness pressure plate with the mounting holes of the left front cover and secure the wire harness in place. Install bolts into the screw holes of the wire harness pressure plate and tighten them.
5. Check whether the clearance between trigger and rotor convex hull is qualified; Tightening torque: 10-14n·m.
6. Combine the O-ring with the large and small viewhole covers, put the o-ring into the left front cover

and tighten it.

**Note:** The trigger locator plate should not press the wire harness.

### Installation of magneto rotor

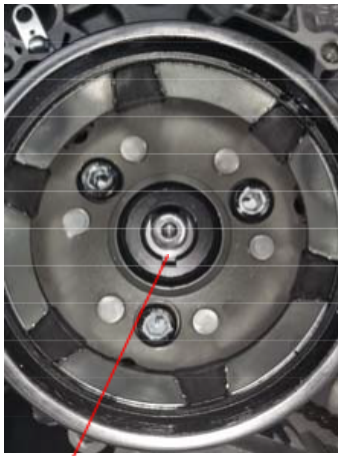

Align the rotor keyway with the crankshaft semicircle key

### Installation of left cover

The steps for installing the left cover are as follows:

1. Remove the old gasket and install a new gasket.
2. Assemble the left crankcase cover in place and tighten it with three GB/T 5787-M6x32 bolts and one GB/T 5787-M6x50 bolt. The tightening torque is 10 to 14 N·m.

Crankcase, crankshaft, main and auxiliary shafts and speed drum

### Matters needing attention

This section describes the transmission, crankshaft installation, testing, to do the above work, the crankcase should be removed first, about the other components of the engine should be removed before the crankcase. Work before crankcase removal:

The disassembly of the cylinder head, the disassembly of the cylinder, the piston, the clutch, the oil pump, the shift mechanism, the disassembly of the balance teeth, the magneto, the disassembly of the transition plate.

### Main parameters and maintenance standards

No.	Items		Standard value	Maintenance limit value	Remark
1	Reverse shift fork	Fork inner diameter	$\Phi 34 \sim \Phi 34.039$	$\Phi 34.041$	
		Thickness of fork claw	4.85~4.95	4.5	
2	crankshaft connecting rod	Inner diameter of connecting rod small head	$\phi 14.016 \sim \phi 14.027$	$\phi 16.025$	
		Axial clearance of large end of connecting rod	0.1~0.3	0.4	
		Radial backlash at big end of connecting rod	0.004~0.012	0.015	

### Fault symptom and cause analysis

No.	Fault symptom	Cause analysis	Remark
1	Shift difficulty	The shift fork is bent and deformed	
		Gaskets and bolts of speed drum loose and loose	
2	Groove-skipping	The pawl of the shift gear is worn	
		The shift fork is bent or worn	
3	Crankshaft noise	The needle roller bearing at the big end of the connecting rod is worn	
		Connecting rod bending	
		The crankshaft bearing is worn	
4	Main and countershaft gear noise	The main and countershaft gears are worn	
		The spline shaft is worn	

### Decomposition of crankcase

The decomposition steps of crankcase are as follows:

1. Place the right crankcase of the engine upward, remove the starting shaft retainer ring, remove the starting shaft return spring and the starting shaft return spring seat;
2. Place the left crankcase of the engine upward; Remove 1 GB/T 5787/ M6x12 bolt and baffle at the hole of the variable speed drum, take out the rubber plug, take out 1 GB/T 5787/ M6x16 bolt and the washer of the variable speed drum;
3. Remove 4 GB/ T5787-M6x65 bolts, 2 GB/ T5787-M6x6 bolts and 1 GB/T5787 / M6x50 bolts, turn the crankcase to separate the left crankcase from the right crankcase, and remove 2 positioning pins and crankcase gaskets.

### Disassembly of crankshaft, main and auxiliary

shaft



### Disassembly of crankshaft, main and auxiliary shaft

1. Take out the crankshaft assembly from the box;
2. Take out the fork shaft, fork, speed change drum and main and auxiliary shaft assembly from the box.

**Note:** ensure that no parts are left behind when taking the main and secondary shaft components.

### Decomposition of variable speed drum

The decomposition steps of the variable speed drum are as follows:

1. Remove the spring clip.
2. Pull out the fork pin.
3. Take out the fork

### Inspection of crankshaft

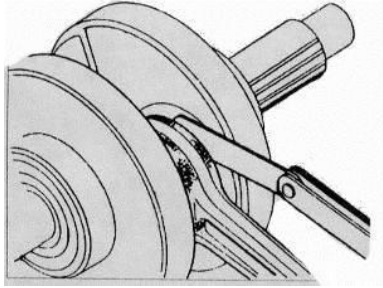

Check the crankshaft as follows:

1. Put the crankshaft on the V-shaped iron, and measure the large side clearance of the connecting rod with the thickness gauge. The limit value of maintenance: 0.4mm;

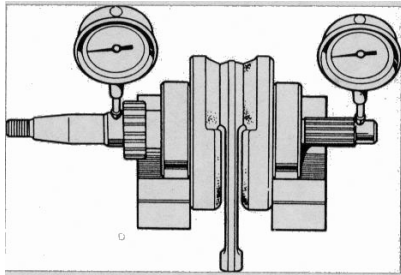

2. Use dial indicator to measure the runout of crankshaft diameter. Actual runout of the crankshaft  
Maintenance limit value: 0.1mm;

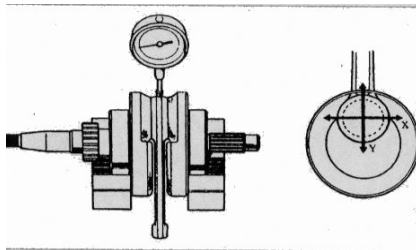

3. Measure the radial gap between the two points in the X and Y direction of the big head of the connecting rod.  
Maintenance limit value: 0.015mm;

### Left and right crankshaft box bearing inspection

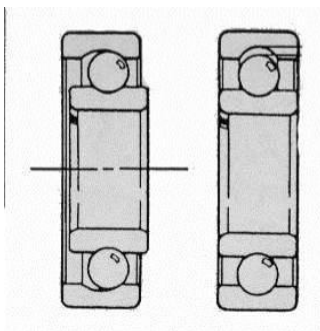

Check the left and right crankshaft box bearings as follows:

1. Check whether all bearings of the left and right boxes rotate flexibly; If the rotation is not flexible or there is a hairpin phenomenon, the bearing of the same type should be replaced;
2. Take down the left and right boxes of the crankshaft bearing to check its diameter jump and end jump, if there is noise or diameter jump and end jump, it should be replaced with a new crankshaft bearing;
3. Check whether the oil channels of the left and right containers are smooth.

### Check shift fork, fork shaft and shift drum

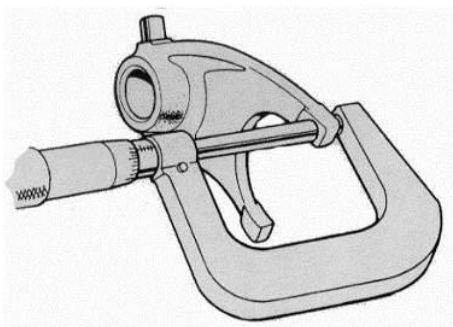

Check the shift fork, fork shaft and speed drum as follows:

1. Check whether the shift fork is worn, bent or any other fault, and measure the inside diameter of the shift fork;  
Fork maintenance limit value:  $\phi$  34.031mm
2. Measure the thickness of the fork;  
Maintenance limit value: 4.5mm
3. Check the surface and groove of the gear drum for wear or damage.

### Check the combination of main and auxiliary shafts





Inspection of starting shaft

Check the main and auxiliary shaft combination as follows:

1. Check whether the gears of main and countershaft assembly have excessive or abnormal wear;
2. Check whether the retainers between gears are deformed or falling off.



Check the starting shaft as follows:

1. Check whether the starting ratchet, starting gear and starting shaft of the starting shaft are excessively or abnormally worn;
2. Check whether the ring is deformed and falls off;
3. Check whether the gasket is deformed or missing.

Assembly of variable speed drum



The assembly steps of the speed drum are as follows:

1. Insert the fork into the speed shifting drum;
2. Install the fork pin;
3. Clamp the spring clip.

Installation of variable speed drum, main and auxiliary shaft, crankshaft and starting shaft

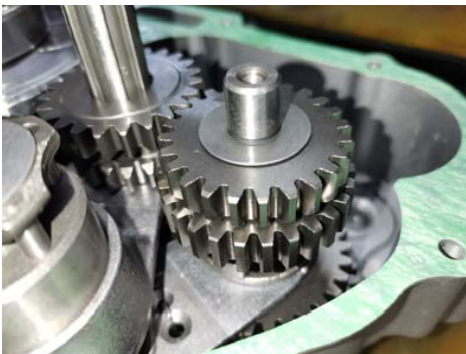

The installation steps of speed drum, main and auxiliary shaft, crankshaft and starting shaft are as follows:

1. Install the crankshaft and starting shaft into the corresponding holes in the left body, and install gaskets after installing the starting shaft;
2. After the main shaft and auxiliary shaft are combined, clamp the shifting fork of the variable speed drum into the fork groove of the main and auxiliary shaft, and then assemble the main and auxiliary shaft assembly and the shifting drum into the corresponding holes in the left body.

**Note:**

1. The shift fork of the speed drum is installed in the main and auxiliary shaft positions.
2. Do not install gaskets of starting shaft and auxiliary shaft.

Installation of crankcase



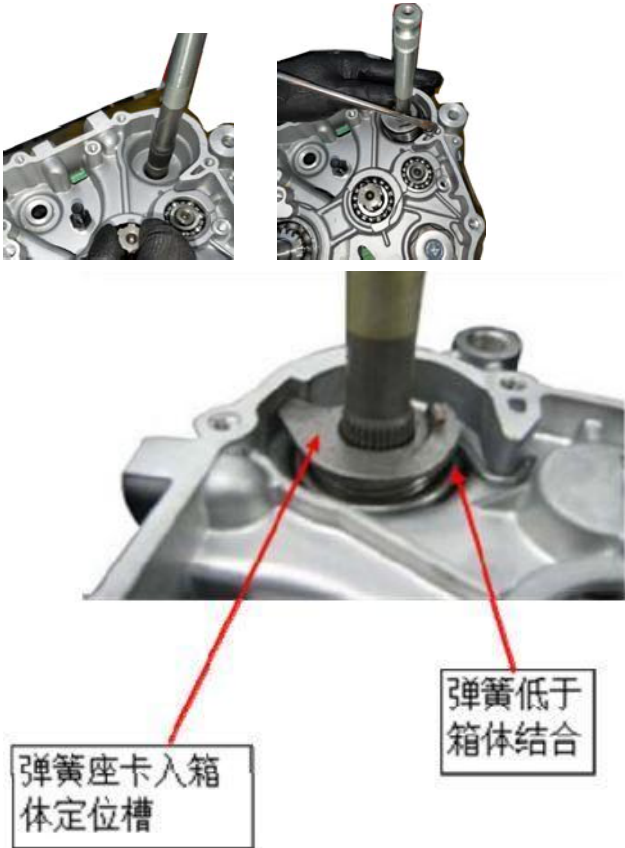

弹簧座卡入箱体定位槽

弹簧低于箱体结合

The installation steps of crankcase are as follows:

1. Install the positioning pin into the corresponding hole in the left box, and then install the crankcase gasket on the left crankshaft box, close the right box on the left box, turn the box, the bolt GB5783 M6x16 and gasket 6×17×2 combination and then load into the variable speed drum threaded hole, then fasten the bolt with the T-shaped sleeve, and turn the secondary shaft when fastening, Determine the vice axis rotation flexibility; Tightening torque: 12-16N·m

Note: The main and secondary axes rotate flexibly without clamping.

2. Insert four GB/ T5777-M6x65 bolts, two GB/ T5777-M6x6 bolts, and one GB/T5787 / M6x50 bolts Bolts pass through the corresponding bolt holes in the left body and tighten them; Tightening torque: 10 ~ 14 N·m.

3. Install rubber plug, baffle and 1 GB/T 5787/ M6x12 bolt at the variable speed drum hole and tighten and turn the engine over.

**Note:** the bolts are not loose, and the auxiliary shaft is flexible without clamping.

4. Rotate the spindle clockwise to make the spindle turn, the starting shaft return spring and return spring seat combination, the spring hook hook spring seat limit block into the starting shaft, with a flat driver to pull the return spring, the spring hook is installed on the right crankshaft box body, and the spring seat card into the box positioning slot.

**Note:**

1. After being in place, check that the spindle rotates flexibly and without sticking;

2. The marking point on the return spring seat should be aligned with the marking point on the starting shaft.

## Engine troubleshooting

For the engine to operate normally, the following four conditions must be met:

1. Good fuel: there is a certain ratio of combustible mixture in the cylinder.
2. Good spark: The spark plug gives off a strong spark at the right time.
3. Sufficient compression: there is enough compression pressure in the cylinder.
4. Valve timing: correct valve opening time.

Engine failure, can focus on the above four aspects, check, analyze the cause of the failure, and to eliminate.

Fault performance	Inspection method	Inspection result	Possible cause		
The engine will not start or has difficulty starting	Check for fuel flow into carburetor	No fuel flow into the carburetor	No fuel in the tank The fuel line from tank to carburetor is blocked		
		Fuel flows into the carburetor	The float assembly in the carburetor is stuck The vent on the tank cap is blocked		
			Remove the spark plug to test the spark	The spark is weak or completely absent	Spark plug failure Spark plug is not clean The electronic ignition is faulty The magneto is out of order
		The spark is good		The connection is bad and broken The high-voltage cable is disconnected or short-circuited The ignition coil is disconnected or short-circuited The ignition switch is faulty	
	Test cylinder pressure			The pressure is too low	The starting mechanism skidded and failed to turn the engine
				The pressure is normal	Valve clearance is too small Valve opening blocked Cylinder or piston ring wear The cylinder head gasket is broken Improper valve timing
			Restart the engine		The engine ignites but will not start

			adjusted
		Engine failure	Air intake pipe leaks Incorrect ignition timing
	Remove the spark plug	The spark plug is damp	Carburetor oil level is too high The carburetor choke closes too tightly
		The spark plug is dry	The throttle is too high
The engine performs poorly at low or idle speeds	Check valve timing and valve clearance	incorrect	Improper adjustment of valve clearance or poor quality of rocker arm adjustment screw
		correct	Improper valve timing adjustment
	Check the adjustment of carburetor plunger trimmer screw	incorrect	Incorrect adjustment
		correct	/
	Check carburetor gasket for leaks	leak	Carburetor seal ring deteriorates
		Not leak	The carburetor is loose Carburetor gasket damaged
	Remove spark plug and perform spark test	The spark is weak or intermittent	Faulty spark plug or charcoal accumulation
			The electronic igniter is faulty The magneto is out of order
		Spark plug is good	The spark plug cap is faulty The power loop is faulty
	The engine performs poorly at high speeds	Check ignition timing and valve clearance	Incorrect
Valve clearance and ignition timing are correct			
Disconnect the carburetor fuel line and check whether it is blocked			Fuel underflow
		Fuel line flow is sufficient	The gas cap vent is blocked
Check filter and carburetor nozzles for blockage		Blocking	The carburetor gauge hole is blocked
		Unplugged	Float stuck filter clogging
Check valve timing		Incorrect	Adjust valve timing
		Correct	/
Check valve spring pressure		Pressure is not enough	Valve springs are worn or broken

The engine is making an abnormal noise	Check whether the valve has abnormal sound	The valve is making an abnormal noise	Valve clearance is too large
			Valve worn
	Check whether abnormal sound occurs in the cylinder	There is an abnormal sound in the cylinder	Piston and cylinder worn
			Wear on small end holes of piston pins and connecting rods
			Crankpin and connecting rod worn
	Check whether the timing chain produces abnormal sound	There is an abnormal sound in the chain	Camshaft worn
			Timing driven sprocket worn
			The timing chain elongated
			Failure of automatic chain tensioner or wear of guide wheel
	Check whether abnormal sound occurs in driving gear and driven gear	The main and driven gears have abnormal sound	Gear machining accuracy is insufficient
		The teeth of the gear are worn	
		The fit clearance between the main and driven gears is too small or too large	

## Motorcycle cleaning

Vehicle cleaning is also an important part of the daily use and maintenance of motorcycles, often clean your motorcycle, can make your car to maintain a good state of motion, prolong its service life. You can clean your motorcycle by following the steps:

1. Cover the exhaust system to prevent water from entering;
2. Seal the electric door lock and connectors with tape;
3. Remove mud and dirt from the surface with a low-pressure water jet;
4. Use special motorcycle cleaner to clean the particularly dirty place;
5. Rinse with low pressure water;
6. Let the motorcycle dry naturally;
7. Drive the motorcycle for a short period of time until the engine reaches the operating temperature;
8. Lubrication chain and all other parts that need lubrication.

**Warning:** Do not use high pressure water to clean vehicles. Avoid direct contact with the coil, plug, carburetor or any electrical element.

## Storage of motorcycles

### The preparation of the motorcycle before long unused

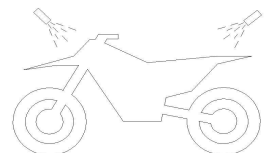

When you plan to store your vehicle and not use it for a long time, follow these steps:

1. Plug the exhaust port of the muffler cylinder;
2. Take out the battery.
3. Clean the motorcycle thoroughly;
4. Wait for the motorcycle to dry naturally;
5. Empty the tank (if not used for a long time, the gasoline will deteriorate);
6. Lubrication chain;
7. Apply oil to all unpainted metal surfaces to prevent rust;
8. When storing the motorcycle, keep the motorcycle wheel suspended, if the condition cannot be reached, the cardboard pad can be used under the motorcycle tire;
9. Cover your motorcycle to prevent dirt and dirt from sticking.
10. Move the motorcycle into a dry room.

**Note:** When applying anti-rust oil, please do not splash the oil on the brake and rubber parts, otherwise it may make the rubber aging.

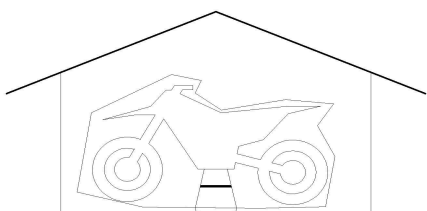

### Prepare a motorcycle before it is put into use after long unused

After storing the motorcycle for a long time, please follow the following steps when putting it into use:

1. Take out the plug at the exhaust vent of the muffler cylinder.
2. Tighten the spark plug.
3. Fill the tank with fuel;
4. Install batteries;
5. Check the items to be checked before daily driving;
6. Regular lubrication of the motorcycle.

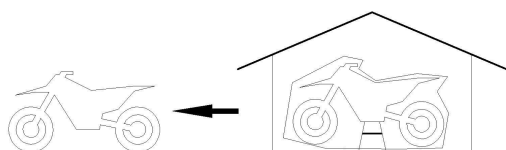

## The main points of maintenance

In the following sections, we will list the problems you encountered, identify the possible causes, and give general solutions.

Problems	Causes	Solutions
The engine crank cannot rotate	Crank stuck	Contact KAYO Service Center
	Cylinder, piston, connecting rod stuck	Contact KAYO Service Center
	Gear box stuck	Contact KAYO Service Center
Press the starter, the engine doesn't respond	The starting relay fuse blew out	Remove the seat cushion and check the fuse. If the fuse is blown, replace the fuse
	The battery is low	Remove seat cushion and check battery
Engine failure	The fuel of the motorcycle has deteriorated from long parking	The old fuel goes out and the new fuel goes in
	There is dirt on the spark plug or the spark plug is wet.	Clean or dry spark plug, replace spark plug if necessary.
	Water had got in the engine.	First of all, put the mixture of fuel in the engine and the engine crankcase removed, clean it with a strong cleaning agent, and then remove the spark plug, with a fan (to inflate the tires of the machine) to dry it, and then wipe the air filter, and finally remove the engine exhaust pipe, dry with a fan. When all is done, the owner should add a new blend of fuel to the engine before riding. Because the water in the crankcase is difficult to completely evaporate, so the new fuel still contains a small amount of water. Therefore, after the engine water, the car ran 100 kilometers, should be changed again, and then 500 kilometers to change again. After three times, the carburetor is almost empty of water. If the cylinder water, in the case of extinguishing, step on the starting rod several times. So step a few times, the water in the cylinder will be discharged



		from the exhaust pipe, and then use the fan to blow on the mouth of the oil ruler for a few minutes. Warning: For safety, wrap the spark plug in a dry cloth to avoid jumping sparks.
	Incorrect mix of air and fuel exhaust open	Clean tank snorkel and adjust air filter duct Check the exhaust valve and correct it
The engine will start, but it will stall immediately	Incorrect air supply The lack of fuel	Close the choke valve, clean the tank ventilation pipe, and adjust the air filter duct make-up fuel supply
The engine is running unevenly	The spark plug is stained, damaged or incorrectly adjusted	Remove the spark plug, clean it, adjust it, and replace it if necessary
	something wrong with the spark plug cap.	Check the condition of the spark plug cap, check whether the spark plug cap is in good contact with the cable itself, check the cable, and replace the damaged parts.
	Ignition rotor damage	Replacement of the rotor
Engine underpower or poor acceleration	The fuel was mixed with water	Empty the fuel and fill it with new fuel
	problems with fuel supply dirt in the air filter	Clean fuel system and check Clean air filter and replace if necessary
	Exhaust system damaged or leaking	Check whether the exhaust system is damaged and replace the accessories if necessary
	Dirt in the carburetor nozzle	Remove carburetor and clean nozzle
	Damaged or worn crankshaft bearings	Contact KAYO Service Center
Abnormal engine sound	Ignition problem	Contact KAYO Service Center
	Overheating	See "Engine overheating" section
The exhaust pipe tempered	There is carbon deposition in the combustion chamber	Contact KAYO Service Center
	Fuel inferior	Replace the fuel
	Spark plug in poor condition or wrong specification	Replace the spark plug with the correct specification
	The gasket of the exhaust system is aged	Check whether the exhaust system is damaged and whether the gasket is in good condition. If the gasket is aging, replace the gasket.
The exhaust pipe emits white smoke	Fuel contains moisture	Replace the fuel
The exhaust pipe belched black smoke	Air filter is blocked	Remove and clean the air filter
	The combustible mixture is too thick	Adjust the carburetor valve
Transmission gears are not engaged	Clutch anomaly	Contact KAYO Service Center
	The fork is bent or stuck	Check and adjust the fork
	Shift lever damaged	Replace shift lever
	The shift drum is damaged	Replace the shift drum
	Ratchet device is damaged	Replace the ratchet device
	The position spring of speed selector is loose or broken	Replace the speed selector position spring
Gear beating	Fork worn	Replace the fork

	Gear groove worn	Check gear and replace if necessary
	Gear damaged	Replace the gear
	The displacement drum groove is damaged	Replace the shift drum
	Fork shaft worn	Check fork shaft and replace if necessary
	The position spring of speed selector is damaged	Replace the speed selector position spring
Clutch slipping	Clutch disc worn	Replace clutch disc
	Clutch pressure plate spring is too soft or damaged	Replace clutch spring
	Clutch free stroke too small	Adjust clutch free stroke
The motorcycle is hard to steer	The cables make it difficult to turn the handlebars	Move the cable to reduce interference
	Steering shaft nut too tight	Adjust the steering shaft nut
	The steering bearing is worn or damaged	Check steering bearings and replace them if necessary
	Bending of steering shaft	Contact KAYO Service Center
Damping is too hard	Oil level of front fork is too high	Lower fork oil level to appropriate position
	Excessive viscosity of fork oil	Replace the fork oil with the proper viscosity
	Front fork bending	Contact KAYO Service Center
	Excessive tire pressure	Check the tire pressure and adjust it to the appropriate pressure
	Error in damping adjustment	Readjust the shock absorption
Damping is too soft	The oil level of the front fork is insufficient	Add proper amount of fork oil Note: The same oil is required
	Low viscosity of fork oil	Replace with fork oil of suitable viscosity
	Tire pressure is too low	Check whether the tire leaks, if the tire vehicle is pumped to the appropriate air pressure
	Error in damping adjustment	Readjust the shock absorption
Abnormal noise when running	Improper chain adjustment	Readjust the chain tension
	The chain worn	Replace the chain and front and rear sprockets
	Rear sprocket teeth worn	Replace the rear sprocket
	Insufficient lubrication of chain	Follow the manual to lubricate the chain
	The rear wheels are off center	Check spokes and center adjust spokes tension as necessary
	Front fork spring is soft or broken	Replace front fork spring
	Disc brake worn	Check the disc brake disc, if its thickness is less than the limit thickness, then replace
	The cylinder head is damaged	Contact KAYO Service Center
	Supports, nuts and bolts are not fastened properly	Check and adjust the torque of the corresponding fasteners
	Gaskets are incorrectly installed, worn or too smooth	Readjust gasket and replace if necessary
The front wheel shimmers	Tyre worn	Replace the tyre

	Rim bias	Contact KAYO Service Center
	Whether the front wheel bearing is worn	Check the bearing and replace it if necessary
	Misalignment of motorcycle	Check the spokes and adjust the tension if necessary
	Excessive tolerance of steering shaft	Check clearance of pressure bearing of steering shaft
	Steering shaft nut loose, handlebars unsecured	Check and retighten
The motorcycle tilted to one side	Chassis bending	Contact KAYO Service Center
	Improper steering adjustment	Check and readjust
	Bending of steering shaft	Contact KAYO Service Center
	There is a problem with the front fork	Contact KAYO Service Center
	Vehicle misalignment	Re-adjust the tension of spokes, and contact KAYO service center if necessary
Brake failure	Disc brake worn	Replace the disk brake
	Insufficient brake fluid	Refill brake fluid
	Brake fluid deterioration	Replace brake oil
	Damage of the piston	Contact KAYO Service Center
	Brake pad worn	Check brake discs and replace brake discs if their thickness is less than the minimum friction thickness

## Vehicle tightening torque meter

**Note:** Before installing the thread, apply anti-rust grease on the thread and bonding surface.

No.	Item	Fastener specification	Qty	Torque (N•m)
1	Front brake caliper bolts	M8×40 full thread	2	20~32
2	Directional column cover	silver chrome finish	1	/
3	Upper pressure block screw	M8×25	4	20~32
4	Front disc brake disc bolts	M8×16	4	25~35
5	Front axle nut	M14×1.5	1	124~165
6	Shift rod bolts	M6×20	1	7~11
7	Engine bolts	M8×110	2	20~32
8	Engine nuts	M8	2	20~32
9	Exhaust pipe nuts	M8	2	20~32
10	Guide chain screw	M6×12	3	7~11
11	Swing arm nuts	M10×1.25	1	40~70
12	Chain adjuster bolts	M8×40 S10	2	20~25
13	Chain adjuster nuts	M8	2	20~25
14	Rear shock bolts	M10×45×1.25	2	40~70
15	Rear shock nuts	M10×1.25	2	40~70
16	Rear brake disc bolts	M8×16	4	25~35
17	Rear sprocket screw	M8×25 10.9	6	27~35
18	Rear axle nuts	M14×1.5	1	124~165
19	Rear brake disc cover bolts	M6×12	2	7~11
20	Rear brake pump bolts	M6×20 full thread	2	7~11
21	Bolts for FBG	M6×20	1	7~11
22	Voltage stabilizer bolts	M6×16 full thread	1	7~11
23	Front fender bolts	M6×16	3	7~11
24	Connecting screws between left and right guard plates and oil tank	M6×10 full thread	4	7~11
25	Left and right guard plates limit bolt	M6×16	2	7~11
26	Fuel tank bolt	M8×25	2	25~30
27	Sparking plug	/	1	25~30